

AQUATIC CONNECTIVITY Stream Crossing Survey DATA FORM

DATABASE ENTRY BY _____ ENTRY DATE _____

DATA ENTRY REVIEWED BY _____ REVIEW DATE _____

CROSSING DATA

Crossing Code _____ Local ID (Optional) _____

Date Observed (00/00/0000) _____ Lead Observer _____

Town/County _____ Stream _____

Road _____ Type MULTILANE PAVED UNPAVED DRIVEWAY TRAIL RAILROAD

GPS Coordinates (Decimal degrees) °N Latitude — °W Longitude

Location Description

Crossing Type BRIDGE CULVERT MULTIPLE CULVERT FORD NO CROSSING REMOVED CROSSING BURIED STREAM INACCESSIBLE PARTIALLY INACCESSIBLE NO UPSTREAM CHANNEL BRIDGE ADEQUATE **Number of Culverts/ Bridge Cells** _____

Photo IDs INLET _____ OUTLET _____ UPSTREAM _____ DOWNSTREAM _____ OTHER _____

Flow Condition NO FLOW TYPICAL-LOW MODERATE HIGH **Crossing Condition** OK POOR NEW UNKNOWN

Tidal Site YES NO UNKNOWN **Alignment** FLOW-ALIGNED SKEWED (>45°) **Road Fill Height** (Top of culvert to road surface; bridge = 0) _____

Bankfull Width (Optional) _____ **Confidence** HIGH LOW/ESTIMATED **Constriction** SEVERE MODERATE SPANS ONLY BANKFULL/ ACTIVE CHANNEL

Tailwater Scour Pool NONE SMALL LARGE SPANS FULL CHANNEL & BANKS

Crossing Comments _____

STRUCTURE 1

Structure Material METAL CONCRETE PLASTIC WOOD ROCK/STONE FIBERGLASS COMBINATION

OUTLET

Outlet Shape 1 2 3 4 5 6 7 FORD UNKNOWN REMOVED **Outlet Armoring** NONE NOT EXTENSIVE EXTENSIVE

Outlet Grade (Pick one) AT STREAM GRADE FREE FALL CASCADE FREE FALL ONTO CASCADE CLOGGED/COLLAPSED/SUBMERGED UNKNOWN

Outlet Dimensions **A. Width** _____ **B. Height** _____ **C. Substrate/Water Width** _____ **D. Water Depth** _____

Outlet Drop to Water Surface _____ **Outlet Drop to Stream Bottom** _____ **E. Abutment Height** (Type 7 bridges only) _____

L. Structure Length (Overall length from inlet to outlet) _____

INLET

Inlet Shape 1 2 3 4 5 6 7 FORD UNKNOWN REMOVED

Inlet Type PROJECTING HEADWALL WINGWALLS HEADWALL & WINGWALLS MITERED TO SLOPE OTHER NONE

Inlet Grade (Pick one) AT STREAM GRADE INLET DROP PERCHED CLOGGED/COLLAPSED/SUBMERGED UNKNOWN

Inlet Dimensions **A. Width** _____ **B. Height** _____ **C. Substrate/Water Width** _____ **D. Water Depth** _____

ADDITIONAL CONDITIONS

Slope % (Optional) _____ **Slope Confidence** HIGH LOW **Internal Structures** NONE BAFFLES/WEIRS SUPPORTS OTHER _____

Structure Substrate Matches Stream NONE COMPARABLE CONTRASTING NOT APPROPRIATE UNKNOWN

Structure Substrate Type (Pick one) NONE SILT SAND GRAVEL COBBLE BOULDER BEDROCK UNKNOWN

Structure Substrate Coverage NONE 25% 50% 75% 100% UNKNOWN

Physical Barriers (Pick all that apply) NONE DEBRIS/SEDIMENT/ROCK DEFORMATION FREE FALL FENCING DRY OTHER

Severity (Choose carefully based on barrier type(s) above) NONE MINOR MODERATE SEVERE

Water Depth Matches Stream YES NO-SHALLOWER NO-DEEPER UNKNOWN DRY

Water Velocity Matches Stream YES NO-FASTER NO-SLOWER UNKNOWN DRY

Dry Passage through Structure? YES NO UNKNOWN **Height above Dry Passage** _____

Comments _____

STRUCTURE 2

Structure Material METAL CONCRETE PLASTIC WOOD ROCK/STONE FIBERGLASS COMBINATION

OUTLET

Outlet Shape 1 2 3 4 5 6 7 FORD UNKNOWN REMOVED Outlet Armoring NONE NOT EXTENSIVE EXTENSIVE

Outlet Grade (Pick one) AT STREAM GRADE FREE FALL CASCADE FREE FALL ONTO CASCADE CLOGGED/COLLAPSED/SUBMERGED UNKNOWN

Outlet Dimensions A. Width _____ B. Height _____ C. Substrate/Water Width _____ D. Water Depth _____

Outlet Drop to Water Surface _____ Outlet Drop to Stream Bottom _____ E. Abutment Height (Type 7 bridges only) _____

L. Structure Length (Overall length from inlet to outlet) _____

INLET

Inlet Shape 1 2 3 4 5 6 7 FORD UNKNOWN REMOVED

Inlet Type PROJECTING HEADWALL WINGWALLS HEADWALL & WINGWALLS MITERED TO SLOPE OTHER NONE

Inlet Grade (Pick one) AT STREAM GRADE INLET DROP PERCHED CLOGGED/COLLAPSED/SUBMERGED UNKNOWN

Inlet Dimensions A. Width _____ B. Height _____ C. Substrate/Water Width _____ D. Water Depth _____

ADDITIONAL CONDITIONS

Slope % (Optional) _____ Slope Confidence HIGH LOW Internal Structures NONE BAFFLES/WEIRS SUPPORTS OTHER _____

Structure Substrate Matches Stream NONE COMPARABLE CONTRASTING NOT APPROPRIATE UNKNOWN

Structure Substrate Type (Pick one) NONE SILT SAND GRAVEL COBBLE BOULDER BEDROCK UNKNOWN

Structure Substrate Coverage NONE 25% 50% 75% 100% UNKNOWN

Physical Barriers (Pick all that apply) NONE DEBRIS/SEDIMENT/ROCK DEFORMATION FREE FALL FENCING DRY OTHER

Severity (Choose carefully based on barrier type(s) above) NONE MINOR MODERATE SEVERE

Water Depth Matches Stream YES NO-SHALLOWER NO-DEEPER UNKNOWN DRY

Water Velocity Matches Stream YES NO-FASTER NO-SLOWER UNKNOWN DRY

Dry Passage through Structure? YES NO UNKNOWN Height above Dry Passage _____

Comments

STRUCTURE 3

Structure Material METAL CONCRETE PLASTIC WOOD ROCK/STONE FIBERGLASS COMBINATION

OUTLET

Outlet Shape 1 2 3 4 5 6 7 FORD UNKNOWN REMOVED Outlet Armoring NONE NOT EXTENSIVE EXTENSIVE

Outlet Grade (Pick one) AT STREAM GRADE FREE FALL CASCADE FREE FALL ONTO CASCADE CLOGGED/COLLAPSED/SUBMERGED UNKNOWN

Outlet Dimensions A. Width _____ B. Height _____ C. Substrate/Water Width _____ D. Water Depth _____

Outlet Drop to Water Surface _____ Outlet Drop to Stream Bottom _____ E. Abutment Height (Type 7 bridges only) _____

L. Structure Length (Overall length from inlet to outlet) _____

INLET

Inlet Shape 1 2 3 4 5 6 7 FORD UNKNOWN REMOVED

Inlet Type PROJECTING HEADWALL WINGWALLS HEADWALL & WINGWALLS MITERED TO SLOPE OTHER NONE

Inlet Grade (Pick one) AT STREAM GRADE INLET DROP PERCHED CLOGGED/COLLAPSED/SUBMERGED UNKNOWN

Inlet Dimensions A. Width _____ B. Height _____ C. Substrate/Water Width _____ D. Water Depth _____

ADDITIONAL CONDITIONS

Slope % (Optional) _____ Slope Confidence HIGH LOW Internal Structures NONE BAFFLES/WEIRS SUPPORTS OTHER _____

Structure Substrate Matches Stream NONE COMPARABLE CONTRASTING NOT APPROPRIATE UNKNOWN

Structure Substrate Type (Pick one) NONE SILT SAND GRAVEL COBBLE BOULDER BEDROCK UNKNOWN

Structure Substrate Coverage NONE 25% 50% 75% 100% UNKNOWN

Physical Barriers (Pick all that apply) NONE DEBRIS/SEDIMENT/ROCK DEFORMATION FREE FALL FENCING DRY OTHER

Severity (Choose carefully based on barrier type(s) above) NONE MINOR MODERATE SEVERE

Water Depth Matches Stream YES NO-SHALLOWER NO-DEEPER UNKNOWN DRY

Water Velocity Matches Stream YES NO-FASTER NO-SLOWER UNKNOWN DRY

Dry Passage through Structure? YES NO UNKNOWN Height above Dry Passage _____

Comments

STRUCTURE 4

Structure Material METAL CONCRETE PLASTIC WOOD ROCK/STONE FIBERGLASS COMBINATION

OUTLET

Outlet Shape 1 2 3 4 5 6 7 FORD UNKNOWN REMOVED Outlet Armoring NONE NOT EXTENSIVE EXTENSIVE

Outlet Grade (Pick one) AT STREAM GRADE FREE FALL CASCADE FREE FALL ONTO CASCADE CLOGGED/COLLAPSED/SUBMERGED UNKNOWN

Outlet Dimensions A. Width _____ B. Height _____ C. Substrate/Water Width _____ D. Water Depth _____

Outlet Drop to Water Surface _____ Outlet Drop to Stream Bottom _____ E. Abutment Height (Type 7 bridges only) _____

L. Structure Length (Overall length from inlet to outlet) _____

INLET

Inlet Shape 1 2 3 4 5 6 7 FORD UNKNOWN REMOVED

Inlet Type PROJECTING HEADWALL WINGWALLS HEADWALL & WINGWALLS MITERED TO SLOPE OTHER NONE

Inlet Grade (Pick one) AT STREAM GRADE INLET DROP PERCHED CLOGGED/COLLAPSED/SUBMERGED UNKNOWN

Inlet Dimensions A. Width _____ B. Height _____ C. Substrate/Water Width _____ D. Water Depth _____

ADDITIONAL CONDITIONS

Slope % (Optional) _____ Slope Confidence HIGH LOW Internal Structures NONE BAFFLES/WEIRS SUPPORTS OTHER _____

Structure Substrate Matches Stream NONE COMPARABLE CONTRASTING NOT APPROPRIATE UNKNOWN

Structure Substrate Type (Pick one) NONE SILT SAND GRAVEL COBBLE BOULDER BEDROCK UNKNOWN

Structure Substrate Coverage NONE 25% 50% 75% 100% UNKNOWN

Physical Barriers (Pick all that apply) NONE DEBRIS/SEDIMENT/ROCK DEFORMATION FREE FALL FENCING DRY OTHER

Severity (Choose carefully based on barrier type(s) above) NONE MINOR MODERATE SEVERE

Water Depth Matches Stream YES NO-SHALLOWER NO-DEEPER UNKNOWN DRY

Water Velocity Matches Stream YES NO-FASTER NO-SLOWER UNKNOWN DRY

Dry Passage through Structure? YES NO UNKNOWN Height above Dry Passage _____

Comments

STRUCTURE 5

Structure Material METAL CONCRETE PLASTIC WOOD ROCK/STONE FIBERGLASS COMBINATION

OUTLET

Outlet Shape 1 2 3 4 5 6 7 FORD UNKNOWN REMOVED Outlet Armoring NONE NOT EXTENSIVE EXTENSIVE

Outlet Grade (Pick one) AT STREAM GRADE FREE FALL CASCADE FREE FALL ONTO CASCADE CLOGGED/COLLAPSED/SUBMERGED UNKNOWN

Outlet Dimensions A. Width _____ B. Height _____ C. Substrate/Water Width _____ D. Water Depth _____

Outlet Drop to Water Surface _____ Outlet Drop to Stream Bottom _____ E. Abutment Height (Type 7 bridges only) _____

L. Structure Length (Overall length from inlet to outlet) _____

INLET

Inlet Shape 1 2 3 4 5 6 7 FORD UNKNOWN REMOVED

Inlet Type PROJECTING HEADWALL WINGWALLS HEADWALL & WINGWALLS MITERED TO SLOPE OTHER NONE

Inlet Grade (Pick one) AT STREAM GRADE INLET DROP PERCHED CLOGGED/COLLAPSED/SUBMERGED UNKNOWN

Inlet Dimensions A. Width _____ B. Height _____ C. Substrate/Water Width _____ D. Water Depth _____

ADDITIONAL CONDITIONS

Slope % (Optional) _____ Slope Confidence HIGH LOW Internal Structures NONE BAFFLES/WEIRS SUPPORTS OTHER _____

Structure Substrate Matches Stream NONE COMPARABLE CONTRASTING NOT APPROPRIATE UNKNOWN

Structure Substrate Type (Pick one) NONE SILT SAND GRAVEL COBBLE BOULDER BEDROCK UNKNOWN

Structure Substrate Coverage NONE 25% 50% 75% 100% UNKNOWN

Physical Barriers (Pick all that apply) NONE DEBRIS/SEDIMENT/ROCK DEFORMATION FREE FALL FENCING DRY OTHER

Severity (Choose carefully based on barrier type(s) above) NONE MINOR MODERATE SEVERE

Water Depth Matches Stream YES NO-SHALLOWER NO-DEEPER UNKNOWN DRY

Water Velocity Matches Stream YES NO-FASTER NO-SLOWER UNKNOWN DRY

Dry Passage through Structure? YES NO UNKNOWN Height above Dry Passage _____

Comments

STRUCTURE 6

Structure Material METAL CONCRETE PLASTIC WOOD ROCK/STONE FIBERGLASS COMBINATION

OUTLET

Outlet Shape 1 2 3 4 5 6 7 FORD UNKNOWN REMOVED Outlet Armoring NONE NOT EXTENSIVE EXTENSIVE

Outlet Grade (Pick one) AT STREAM GRADE FREE FALL CASCADE FREE FALL ONTO CASCADE CLOGGED/COLLAPSED/SUBMERGED UNKNOWN

Outlet Dimensions A. Width _____ B. Height _____ C. Substrate/Water Width _____ D. Water Depth _____

Outlet Drop to Water Surface _____ Outlet Drop to Stream Bottom _____ E. Abutment Height (Type 7 bridges only) _____

L. Structure Length (Overall length from inlet to outlet) _____

INLET

Inlet Shape 1 2 3 4 5 6 7 FORD UNKNOWN REMOVED

Inlet Type PROJECTING HEADWALL WINGWALLS HEADWALL & WINGWALLS MITERED TO SLOPE OTHER NONE

Inlet Grade (Pick one) AT STREAM GRADE INLET DROP PERCHED CLOGGED/COLLAPSED/SUBMERGED UNKNOWN

Inlet Dimensions A. Width _____ B. Height _____ C. Substrate/Water Width _____ D. Water Depth _____

ADDITIONAL CONDITIONS

Slope % (Optional) _____ Slope Confidence HIGH LOW Internal Structures NONE BAFFLES/WEIRS SUPPORTS OTHER _____

Structure Substrate Matches Stream NONE COMPARABLE CONTRASTING NOT APPROPRIATE UNKNOWN

Structure Substrate Type (Pick one) NONE SILT SAND GRAVEL COBBLE BOULDER BEDROCK UNKNOWN

Structure Substrate Coverage NONE 25% 50% 75% 100% UNKNOWN

Physical Barriers (Pick all that apply) NONE DEBRIS/SEDIMENT/ROCK DEFORMATION FREE FALL FENCING DRY OTHER

Severity (Choose carefully based on barrier type(s) above) NONE MINOR MODERATE SEVERE

Water Depth Matches Stream YES NO-SHALLOWER NO-DEEPER UNKNOWN DRY

Water Velocity Matches Stream YES NO-FASTER NO-SLOWER UNKNOWN DRY

Dry Passage through Structure? YES NO UNKNOWN Height above Dry Passage _____

Comments

STRUCTURE 7

Structure Material METAL CONCRETE PLASTIC WOOD ROCK/STONE FIBERGLASS COMBINATION

OUTLET

Outlet Shape 1 2 3 4 5 6 7 FORD UNKNOWN REMOVED Outlet Armoring NONE NOT EXTENSIVE EXTENSIVE

Outlet Grade (Pick one) AT STREAM GRADE FREE FALL CASCADE FREE FALL ONTO CASCADE CLOGGED/COLLAPSED/SUBMERGED UNKNOWN

Outlet Dimensions A. Width _____ B. Height _____ C. Substrate/Water Width _____ D. Water Depth _____

Outlet Drop to Water Surface _____ Outlet Drop to Stream Bottom _____ E. Abutment Height (Type 7 bridges only) _____

L. Structure Length (Overall length from inlet to outlet) _____

INLET

Inlet Shape 1 2 3 4 5 6 7 FORD UNKNOWN REMOVED

Inlet Type PROJECTING HEADWALL WINGWALLS HEADWALL & WINGWALLS MITERED TO SLOPE OTHER NONE

Inlet Grade (Pick one) AT STREAM GRADE INLET DROP PERCHED CLOGGED/COLLAPSED/SUBMERGED UNKNOWN

Inlet Dimensions A. Width _____ B. Height _____ C. Substrate/Water Width _____ D. Water Depth _____

ADDITIONAL CONDITIONS

Slope % (Optional) _____ Slope Confidence HIGH LOW Internal Structures NONE BAFFLES/WEIRS SUPPORTS OTHER _____

Structure Substrate Matches Stream NONE COMPARABLE CONTRASTING NOT APPROPRIATE UNKNOWN

Structure Substrate Type (Pick one) NONE SILT SAND GRAVEL COBBLE BOULDER BEDROCK UNKNOWN

Structure Substrate Coverage NONE 25% 50% 75% 100% UNKNOWN

Physical Barriers (Pick all that apply) NONE DEBRIS/SEDIMENT/ROCK DEFORMATION FREE FALL FENCING DRY OTHER

Severity (Choose carefully based on barrier type(s) above) NONE MINOR MODERATE SEVERE

Water Depth Matches Stream YES NO-SHALLOWER NO-DEEPER UNKNOWN DRY

Water Velocity Matches Stream YES NO-FASTER NO-SLOWER UNKNOWN DRY

Dry Passage through Structure? YES NO UNKNOWN Height above Dry Passage _____

Comments

Structure Shape & Dimensions

- 1) Select the Structure Shape number from the diagrams below and record it on the form for Inlet and Outlet Shape.
- 2) Record on the form in the appropriate blanks dimensions **A**, **B**, **C** and **D** as shown in the diagrams;
C captures the width of water or substrate, whichever is wider; for dry culverts without substrate, C = 0.
D is the depth of water -- be sure to measure inside the structure; for dry culverts, D = 0.
- 3) Record Structure Length (**L**). (Record abutment height (**E**) only for Type 7 Structures.)
- 4) For multiple culverts, also record the Inlet and Outlet shape and dimensions for each additional culvert.

NOTE: Culverts 1, 2 & 4 may or may not have substrate in them, so height measurements (B) are taken from the level of the "stream bed", whether that bed is composed of substrate or just the inside bottom surface of a culvert (grey arrows below show measuring to bottom, black arrows show measuring to substrate).

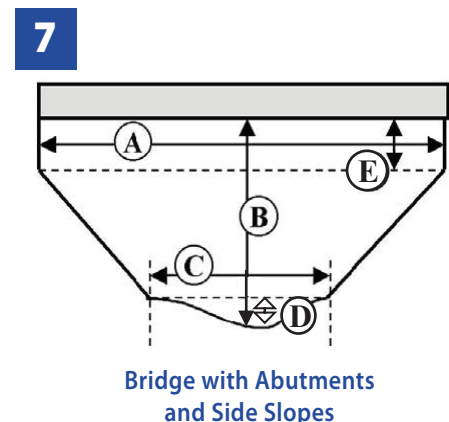
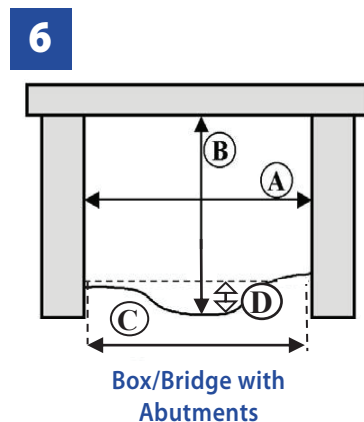
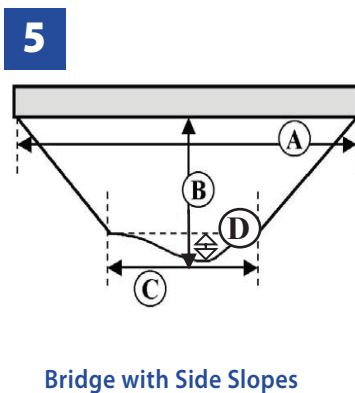
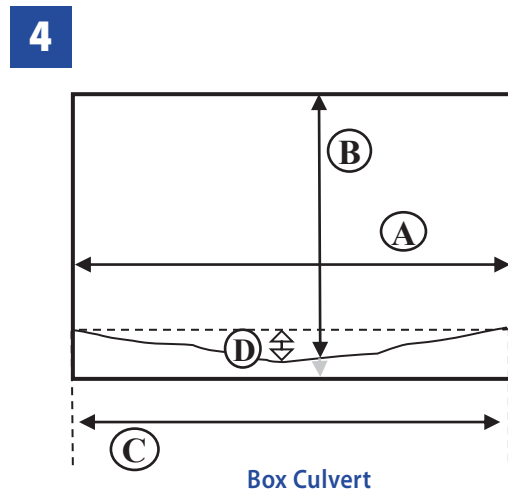
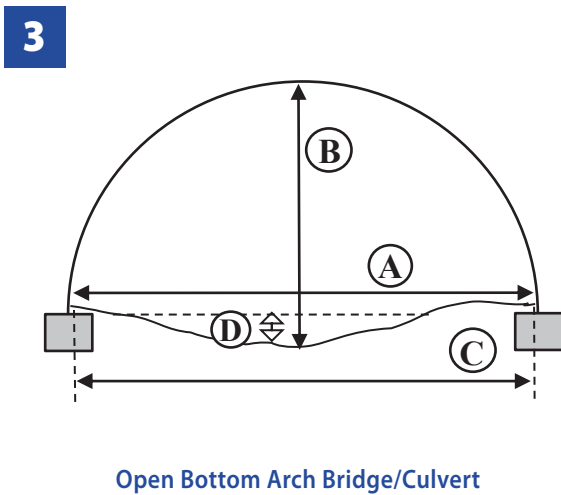
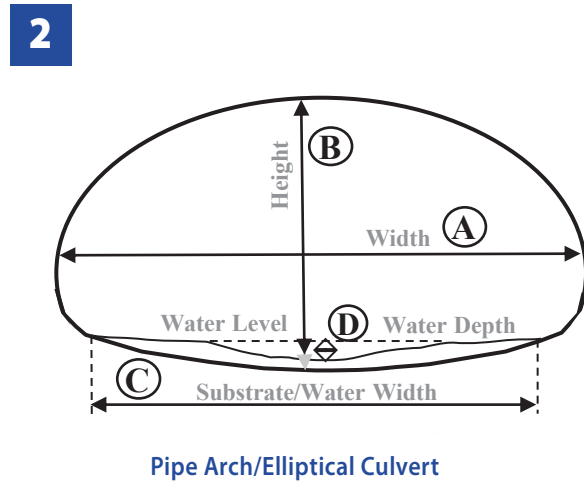
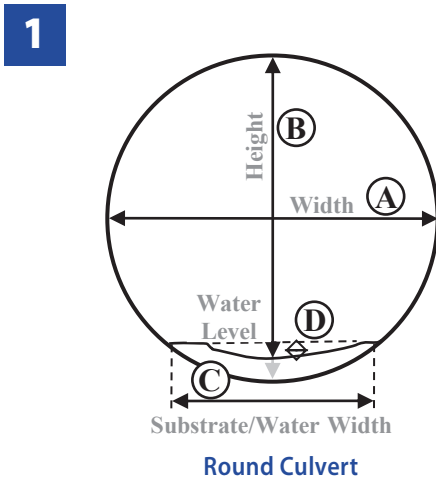

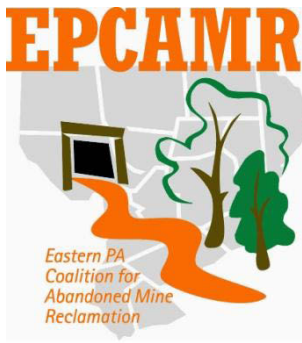

Station Information (adapted from PA DEP Bureau of Water Standards Form 3800-FM-WSFR0086 Rev. 12/2008)

Date-Time-Initials: _____ - _____ - _____ Station ID: _____

Watershed Code(HUC): _____ Stream Code: _____ SWP Code: _____

County: _____ Municipality: _____ Topo Quad: _____

Location (ex. Latitude/Longitude, directions, landmarks...) : _____

Survey Type (see below): _____ Ch. 93 Use: _____ Weather - Current: _____ - Past Week: _____

- (1) Basin Survey, (2) Cause / Effect, (3) Fish Tissue, (4) Instream Comprehensive Evaluation [ICE], (5) Point-of-First-Use, (6) SERA, (7) Anti-degradation [Special Protection], (8) Toxics, (10) Use Attainability, (11) WQN, (12) Limestone, (13) Low-gradient [Multi-habitat], (14) AMD Treatment

Physical Conditions (adapted from WV SOS Level one Survey Datasheet 18373 Rev. 11/2009) (circle one or more):

Water Clarity: *clear, murky, milky, muddy, other* Water Color: *none, brown, black, orange/red, gray/white, green*

Water Odor: *none, fishy, musky, rotten egg, sewage, chemical* Surface Foam: *none, slight, moderate, high*

Streambed Color: *brown, black, green, white/gray, orange/red* Algae Abundance: *none, scattered, moderate, heavy*

Algae Growth Habit: *even coating, hairy, matted, floating* Algae Color: *light green, dark green, brown, other*

Field Chemistry (adapted from WV SOS Level one Survey Datasheet 18373 Rev. 11/2009)

<table border="0"> <tr> <td style="width: 30%;"></td> <td style="text-align: center;">Result</td> <td style="text-align: center;">Unit</td> </tr> <tr> <td>Temperature:</td> <td>_____</td> <td>_____</td> </tr> <tr> <td>Dissolved Oxygen:</td> <td>_____</td> <td>_____</td> </tr> <tr> <td>pH:</td> <td>_____</td> <td>_____</td> </tr> </table>		Result	Unit	Temperature:	_____	_____	Dissolved Oxygen:	_____	_____	pH:	_____	_____	<table border="0"> <tr> <td style="width: 30%;"></td> <td style="text-align: center;">Result</td> <td style="text-align: center;">Unit</td> </tr> <tr> <td>Total Alkalinity:</td> <td>_____</td> <td>_____</td> </tr> <tr> <td>Total Acidity:</td> <td>_____</td> <td>_____</td> </tr> <tr> <td>Total Iron:</td> <td>_____</td> <td>_____</td> </tr> </table>		Result	Unit	Total Alkalinity:	_____	_____	Total Acidity:	_____	_____	Total Iron:	_____	_____
	Result	Unit																							
Temperature:	_____	_____																							
Dissolved Oxygen:	_____	_____																							
pH:	_____	_____																							
	Result	Unit																							
Total Alkalinity:	_____	_____																							
Total Acidity:	_____	_____																							
Total Iron:	_____	_____																							

Additional tests (describe and record results): _____

Flow Calculation (adapted from WV SOS Level one Survey Datasheet 18373 Rev. 11/2009)

Channel Width: _____

Method Used (circle one): *flow meter, float, velocity head rod (VHR)*

VHR Calculations

Tape distance (ft)	Depth (ft)	Velocity (ft/sec)	Float (sec)	VHR (Rise-inches)	Discharge (cfs)	Rise	Velocity	Rise	Velocity
1						¼	1.2	¾	4.2
2						½	1.6	¾	4.3
3						¾	2	¾	4.5
4						1	2.3	4	4.6
5						1 ¼	2.6	4 ¼	4.8
6						1 ½	2.8	4 ½	4.9
7						1 ¾	3.1	4 ¾	5
8						2	3.3	5	5.2
9						2 ¼	3.5	5 ¼	5.3
10						2 ½	3.7	5 ½	5.4
Totals/Averages						2 ¾	3.8	5 ¾	5.5
						3	4	6	5.7

Discharge (cfs)= Width (ft) x Avg. Depth(ft) x Avg. Velocity (ft/sec.)

If you use the "float method" record your float distance here _____ (ft) and multiply by the number of seconds it took in the column indicated above to get velocity.

Habitat Visual Assessment (adapted from PA DEP Bureau of Water Standards Form 3800-FM-WSFR0402 Rev. 10/2008)

Particle Size Descriptors: Silt (slick feel), Sand (grainy feel), Gravel (> pea), Cobble (> tennis ball), Boulder (> basketball), and Bedrock (> car).

Habitat Parameter Part 1	Category																			
	Optimal					Suboptimal					Marginal					Poor				
1. Instream Cover (Fish)	Greater than 50% mix of boulder, cobble, sub-merged logs, undercut banks, or other stable habitat.					30-50% mix of boulder, cobble, or other stable habitat; adequate habitat.					10-30% mix of boulder, cobble, or other stable habitat; habitat availability less than desirable.					Less than 10% mix of boulder, cobble, or other stable habitat; lack of habitat is obvious.				
SCORE _____	20	19	18	17	16	15	14	13	12	11	10	9	8	7	6	5	4	3	2	1
2. Epifaunal Substrate	Well developed riffle and run, riffle is as wide as stream and length extends two times the width of stream; abundance of cobble.					Riffle is as wide as stream but length is less than two times width; abundance of cobble; boulders and gravel common.					Run area may be lacking; riffle not as wide as stream and its length is less than two times the stream width; gravel or large boulders and bedrock prevalent; some cobble present.					Riffles or run virtually nonexistent; large boulders and bedrock prevalent; cobble lacking.				
SCORE _____	20	19	18	17	16	15	14	13	12	11	10	9	8	7	6	5	4	3	2	1
3. Embeddedness	Gravel, cobble, and boulder particles are 0-25% surrounded by fine sediment (silt=slick or sand=grainy feel).					Gravel, cobble, and boulder particles are 25-50% surrounded by fine sediment.					Gravel, cobble, and boulder particles are 50-75% surrounded by fine sediment.					Gravel, cobble, and boulder particles are more than 75% surrounded by fine sediment.				
SCORE _____	20	19	18	17	16	15	14	13	12	11	10	9	8	7	6	5	4	3	2	1
4. Velocity/Depth Regimes	All four velocity/depth regimes present (slow-deep, slow-shallow, fast-deep, fast-shallow).					Only 3 of the 4 regimes present (if fast-shallow is missing, score lower than if missing other regimes).					Only 2 of the 4 habitat regimes present (if fast-shallow or slow-shallow are missing, score lower than if missing other regimes).					Dominated by 1 velocity/depth regime (usually slow-deep).				
SCORE _____	20	19	18	17	16	15	14	13	12	11	10	9	8	7	6	5	4	3	2	1
5. Channel Alteration	No channelization or dredging present.					Some channelization present, usually in areas of bridge abutments; evidence of past channelization, i.e., dredging, (greater than past 20 yr) may be present, but recent channelization is not present.					New embankments present on both banks; and 40-80% of stream reach channelized and disrupted.					Banks shored gabion or cement; over 80% of the stream reach channelized and disrupted.				
SCORE _____	20	19	18	17	16	15	14	13	12	11	10	9	8	7	6	5	4	3	2	1
6. Sediment Deposition	Little or no enlargement of islands or point bars and less than 5% of the bottom affected by sediment deposition.					Some new increase in bar formation, mostly from coarse gravel; 5-30% of the bottom affected; slight deposition in pools.					Moderate deposition of new gravel, coarse sand on old and new bars; 30-50% of the bottom affected; sediment deposits at obstruction, constriction, and bends; moderate deposition of pools prevalent.					Heavy deposits of fine material, increased bar development; more than 50% of the bottom changing frequently; pools almost absent due to substantial sediment deposition.				
SCORE _____	20	19	18	17	16	15	14	13	12	11	10	9	8	7	6	5	4	3	2	1
Total Part 1 _____																				

Habitat Parameter Part 2	Category																			
	Optimal					Suboptimal					Marginal					Poor				
7. Frequency of Riffles	Occurrence of riffles relatively frequent; distance between riffles divided by the width of the stream equals 5 to 7; variety of habitat.					Occurrence of riffles infrequent; distance between riffles divided by the width of the stream equals 7 to 15.					Occasional riffle or bend; bottom contours provide some habitat; distance between riffles divided by the width of stream is between 15 to 25.					Generally all flat water or shallow riffles; poor habitat; distance between riffles divided by the width of the stream is between ratio >25.				
SCORE _____	20	19	18	17	16	15	14	13	12	11	10	9	8	7	6	5	4	3	2	1
8. Channel Flow Status	Water reaches base of both lower banks and minimal amount of channel substrate is exposed.					Water fills > 75% of the available channel; or <25% of channel substrate is exposed.					Water fills 25-75% of the available channel and/or riffle substrates are mostly exposed.					Very little water in channel and mostly present as standing pools.				
SCORE _____	20	19	18	17	16	15	14	13	12	11	10	9	8	7	6	5	4	3	2	1
9. Condition of Banks	Banks stable; no evidence of erosion or bank failure.					Moderately stable; infrequent, small areas of erosion mostly healed over.					Moderately unstable; up to 60% of banks in reach have areas of erosion.					Unstable; many eroded areas; "raw" areas frequent along straight sections and bends; on side slopes, 60-100% of bank has erosional scars.				
SCORE _____	20	19	18	17	16	15	14	13	12	11	10	9	8	7	6	5	4	3	2	1
10. Bank Vegetative Protection	More than 90% of the streambank surface covered by vegetation.					70-90% of the stream-bank surface covered by vegetation.					50-70% of the stream-bank surfaces covered by vegetation.					Less than 50% of the streambank surface covered by vegetation.				
SCORE _____	20	19	18	17	16	15	14	13	12	11	10	9	8	7	6	5	4	3	2	1
11. Grazing or Other Disruptive Pressure	Vegetative disruption, through grazing or mowing, minimal or not evident; almost all plants allowed to grow naturally.					Disruption evident but not affecting full plant growth potential to any great extent; more than one-half of the potential plant stubble height remaining.					Disruption obvious; patches of bare soil or closely cropped vegetation common; less than one-half of the potential plant stubble height remaining.					Disruption of vegetation is very high; vegetation has been removed to 2 inches or less in average stubble height.				
SCORE _____	20	19	18	17	16	15	14	13	12	11	10	9	8	7	6	5	4	3	2	1
12. Riparian Vegetative Zone Width	Width of riparian zone >18 meters; human activities (i.e., parking lots, roadbeds, clear-cuts, lawns, or crops) have not impacted zone.					Width of riparian zone 12-18 meters; human activities have impacted zone only minimally.					Width of riparian zone 6-12 meters; human activities have impacted zone a great deal.					Width of riparian zone <6 meters; little or no riparian vegetation due to human activities.				
SCORE _____	20	19	18	17	16	15	14	13	12	11	10	9	8	7	6	5	4	3	2	1
Total Part 2 _____																				

Total Score _____ If < 140 for forested, cold water & high gradient (<120 for warm water low gradient), then generally impaired

Impairment Thresholds

#3 Embeddedness + #6 Sediment Deposition: _____ If < 24 (<20 for warm water low gradient), then impaired by sediment

#9 Condition of Banks + #10 Bank Vegetation: _____ If < 24 (<20 for warm water low gradient), then impaired by bank erosion

Land Use

Residential: _____% Commercial: _____% Industrial: _____% Cropland: _____% Pasture: _____% Abd. Mining: _____%

Old Fields: _____% Forest: _____% Other: _____% Canopy cover: open partly shaded mostly shaded fully shaded

Habitat Comments: _____











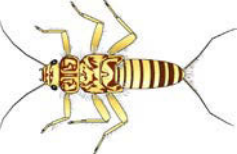
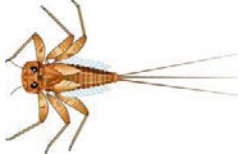

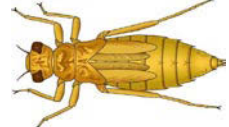
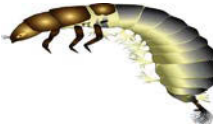

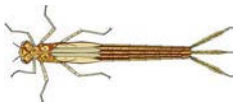



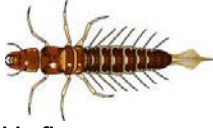





Benthic Macro-invertebrates (adapted from WV SOS Level One Survey Datasheet 18373 11/2009) .

The dot dash tally method is a convenient way to record data. Each dot or dash represents one tally. --->

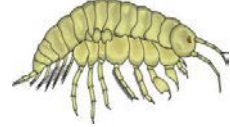
1	2	3	4	5	6	7	8	9	10
•	••	•••	••••	•••••	••••••	•••••••	••••••••	•••••••••	••••••••••

Sampling Method Used? (circle one): Std. Kick Screen, D-Frame Net, Surber Sampler, Other

Benthic macroinvertebrates: Use the table below to record information about your collections. Record their abundance using this code: **(A) > 50, (C) 5 – 50 and (R) < 5**. Also record the number of different kinds. The **# of kind's** box indicates groups in which multiple kinds (**families**) are possible. If collected, include the **free-living caddisfly** with the other net-spinners. (Illustrations are courtesy of the **Cacapon Institute**; Jennifer Gillies, artist)

 Stoneflies	# of kinds <input type="text"/>	 Mayflies	# of kinds <input type="text"/>	 Caddisflies	Case-builders # of kinds <input type="text"/>
 Dragonflies	# of kinds <input type="text"/>	 Common netspinner		 Caddisflies	Net-spinners # of kinds <input type="text"/>
 Damsel flies	# of kinds <input type="text"/>	 Riffle beetle		 Water penny	
 Hellgrammite		 Alderfly		 Other beetles	# of kinds <input type="text"/>
 Midges		 Black fly		 Crane fly	
 Watersnipe fly		 Other flies	# of kinds <input type="text"/>	 Crayfish	
 Clams	# of kinds <input type="text"/>	 Mussel		 Scud/Sideswimmer	
 Operculate snails	# of kinds <input type="text"/>	 Non-operculate snails	# of kinds <input type="text"/>	 Aquatic sowbug	
 Aquatic worm		 Leech		 Flatworm	

Other aquatic life observed or collected: _____ **Total # of Kinds**



Rapid Biological Assessment Protocols: An Introduction



NOTICE: This PDF file was adapted from an on-line training module of the EPA's *Watershed Academy Web*, found at <http://www.epa.gov/watertrain>. To the extent possible, it contains the same material as the on-line version. Some interactive parts of the module had to be reformatted for this non-interactive text presentation.

This document does not constitute EPA policy. Mention of trade names or commercial products does not constitute endorsement or recommendation for use.

Links to non-EPA web sites do not imply any official EPA endorsement of or responsibility for the opinions, ideas, data, or products presented at those locations or guarantee the validity of the information provided. Links to non-EPA servers are provided solely as a pointer to information that might be useful to EPA staff and the public.

Welcome to the Rapid Bioassessment Protocols (RBPs) training module. The information in this module introduces the use of RBPs as an efficient, cost-effective **bioassessment** method. For further technical information, the entire document (approx. 300 pages) on which this module is based, *Rapid Bioassessment Protocols for Use in Streams and Wadeable Rivers: Periphyton, Benthic Macroinvertebrates, and Fish, Second Edition*, can be downloaded from the Monitoring Program website of the USEPA Office of Wetlands, Oceans, and Watersheds (www.epa.gov/owow/monitoring/rbp/download.html).

The goals of our training module are to:

- Introduce the approach and methods for rapid bioassessment,
- Highlight the ways rapid bioassessment may be used in stream monitoring, planning, management, and restoration efforts, and
- Point out the strengths of rapid bioassessment (see Table 1)

Strengths of Biological Surveys

- Bioassessment provides indications of cumulative impacts of multiple stressors, not just water quality.
- Biological community condition reflects both short- and long-term effects, and directly evaluates the condition of the water resource.
- Biological data can be interpreted based on regional reference condition where single reference sites are lacking or inadequate.
- Properly developed methods, metrics, and reference conditions provide a tool that enables a direct measure of the ecological condition of a waterbody.
- Once a framework is in place for bioassessment, biological monitoring can be relatively inexpensive, and easily performed with standard protocols and consistent training.

Table 1

Throughout the module, **underlined terms in bold** are listed out in the glossary on page 35 at the end of this module.

Overview

The Rapid Bioassessment Protocols were originally developed in the 1980's to provide cost-effective, efficient biological survey techniques. Figure 1 shows a comparison of levels of effort required for traditional sampling versus rapid bioassessment. They have since been revised and were reissued in 1999. The concepts underlying the RBPs are:

- Cost-effective, scientifically valid procedures for biological surveys,
- Provisions for multiple site investigations in a field season,
- Quick turn-around of results for management decisions, and
- Scientific reports easily translated to management and the public.

Figure 1

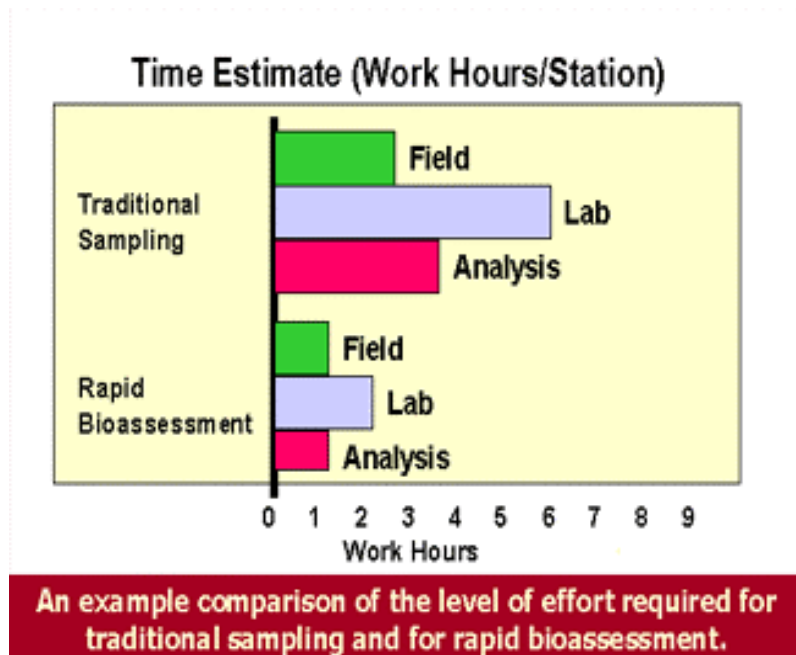

The RPBs were synthesized from existing bioassessment methods used by several state water resource agencies (Figure 2). Figure 3 on the next page shows a map of states with rapid bioassessment programs.



Figure 2

Forty-three states currently use bioassessments in non-regulatory water resource management. Once the framework for bioassessment is established, biological monitoring can be easily and rather inexpensively performed using the RBPs. Following, are examples of how two state agencies are using the RPBs in their water resource programs:



Figure 5

Development of the Stream Condition Index (SCI) for Florida

The Florida Department of Environmental Protection carries out monitoring and assessment programs that rely heavily on biological data. In Florida, the quality of surface water is affected primarily by nonpoint sources of water pollution. In 1991, the Florida DEP formed a Biocriteria committee to coordinate the development of rapid bioassessment protocols and a biological index for the state's streams. The goal of the Biocriteria committee is **using biological indicators to assess ecosystem health, identify problems, and offer solutions.** The objective in developing the protocols and index was to address the following questions:

- What is the most appropriate site classification for assessment of ecosystem health?
- Is site classification the same for winter and summer index periods?
- What is the annual variability within an index period for the biological metrics?
- What are the seasonal differences in the biological metrics among years? Are two index periods per year needed for monitoring?
- What are the appropriate metrics for a Stream Condition Index (SCI) for each season?

The groundwork of bioassessment is the establishment of reference conditions. Reference conditions are the optimal available conditions where biological potential is at its highest in a particular region. For Florida, reference conditions are characterized within three bioregions, with each bioregion sharing similar physical, chemical, and biological characteristics. Biological attributes are measured in each bioregion and compared to the appropriate reference condition. The Florida DEP uses the benthic (bottom-dwelling) macroinvertebrate assemblage to measure various biological characteristics. Seven benthic macroinvertebrate metrics are used, which measure diversity, composition, and functional feeding group representation, and provide information on pollution tolerance. The information from these metrics are combined to generate a Stream Condition Index (SCI) for Florida.

The SCI is the primary indicator for ecosystem health for the state and is used as the basis for assessment in the nonpoint-source program. The expected benefits of using the SCI apply to various aspects of management, including:

- characterizing the existence and severity of point and nonpoint source impairment,
- targeting watersheds and ecosystem management areas for recovery or preventative programs,
- evaluating the effectiveness of nonpoint source best management programs,
- screening ecosystems for use attainability, and
- developing new biocriteria that relate to regional water quality goals

Development of a Biological Assessment Approach for Alaska Streams: a Pilot Study on the Kenai Peninsula

Biological assessments have been done in Alaska over the past ten years to fulfill specific project objectives. However, there is no standardized sampling methodology for the state, and sporadic sampling efforts have left many "holes" in the data. These issues have contributed to difficulties for Alaska in carrying out its nonpoint source pollution control program. Coordination and communication between different groups conducting assessments can be difficult, especially when different methodologies and metrics are being used. Coupled with these problems are funding constraints and the logistical challenges of accessing many parts of the state.

In Alaska, nonpoint sources of water pollution are of the utmost concern. The Alaska Department of Environmental Conservation (ADEC) is responsible for maintaining and protecting the health of the state's waters. In 1997, ADEC formed a bioassessment work group to develop Rapid Bioassessment Protocols for the state. Rapid bioassessment is an extremely cost-effective biological monitoring strategy. It requires a minimal amount of effort, yet yields reproducible, scientifically valid results; this allows the agency to optimize its resources. A pilot study on the Kenai Peninsula was done to establish a rapid bioassessment technique based on the regional reference conditions of the area. The goals of this study were to:

- develop a regional reference condition for the Kenai Peninsula for use in biological assessment and monitoring,
- evaluate the modified Rapid Bioassessment Protocols that were adapted for Alaska and that would become the basis for ADEC's nonpoint source pollution monitoring program, and
- calibrate benthic macroinvertebrate metrics to detect impairment and to develop a multimetric index for use in biological assessments for Alaska streams.

Regional reference conditions represent sustainable ecosystem health for a certain geographical area. The reference conditions for Alaska streams on the Kenai Peninsula are best characterized for two stream categories, moderate-gradient (fast and medium velocity) and low-gradient (slow velocity). These two categories partition the drainage areas of the Peninsula according to similar physical, chemical, and biological characteristics. ADEC uses measures of the biological attributes of benthic (bottom-dwelling) macroinvertebrates to determine stream health. Seven metrics are used to measure diversity, taxonomic composition, and pollution tolerance. The

information obtained from these metrics are used to develop the Alaska Stream Condition Index (ASCI), which is now used as the primary gauge of ecosystem health for the state.

Reference Sites

Rapid bioassessment is based on comparing **habitat**, water quality, and biological measures of a given stream with an expected state, or stream **reference condition**, that would exist in the same type of stream in the absence of human disturbance. Reference conditions are established by assessing "minimally" impaired stream sites, as it is rarely possible to find streams with no impairment at all. **Reference sites** should be established in good examples of the different types of streams found in the region (Figure 6). Regional reference characteristics represent the best attainable conditions for all streams with similar physical characteristics. The *site-specific control* is a segment of the stream being studied that represents the best attainable conditions for that stream.

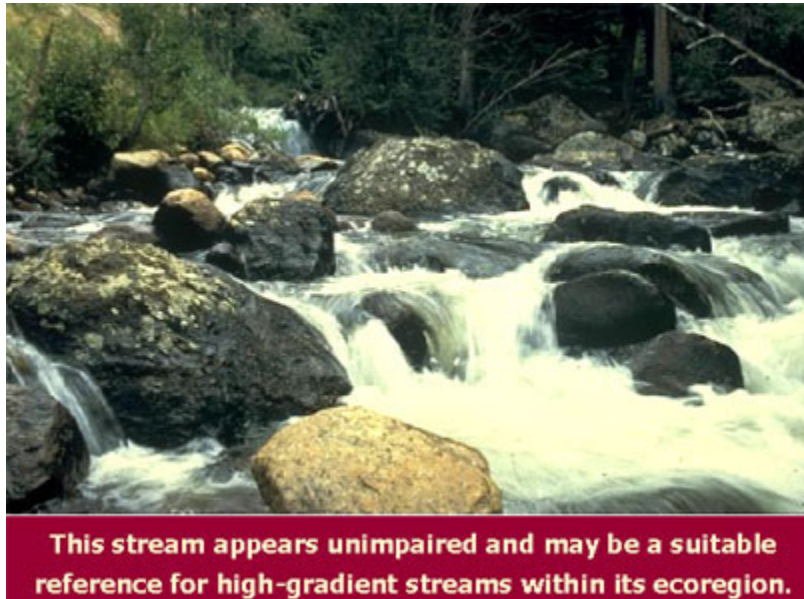

Figure 6

Stream sites are classified into categories that would have similar aquatic communities under ideal conditions. The classification is based on characteristics that are intrinsic to the site (such as elevation, watershed size, stream gradient, soils, geology and other factors), *not* those resultant from human-induced change.

It is essential to classify stream sites before assessment, because comparing an assessed stream to a very different type of reference stream can lead to incorrect conclusions about condition. Comparing condition attributes between unlike sites is like comparing apples to oranges; the differences will have little relevant meaning. When the **variance** is partitioned so that similar sites are grouped together, the assessment and comparison is made more meaningful. The reference condition establishes the basis for making these comparisons and for detecting aquatic life impairment within each type of stream.

Because there are very few undisturbed streams left in the world, the establishment of the reference condition requires a decision on the "acceptability" of the reference sites after considering many criteria (see Table 2 for criteria) The candidate reference sites should be assessed to determine their level of impairment relative to other sites in the geographic region. The characteristics of an acceptable "undisturbed" condition will likely vary from one region (and type of stream) to the next. The goal is to establish an expected condition that best represents the biological characteristics that you would anticipate finding in an undisturbed

setting, acknowledging the limited information you may have about the past. When defining this expected condition, the physical characteristics of the region are key information. In addition to using reference sites, the reference condition is also based on historical data, **empirical models**, and expert opinion.

Example Criteria for Reference Sites (Must meet all criteria)
<ul style="list-style-type: none">• pH ≥ 6; if blackwater stream, then pH ≤ 6 and DOC > 8 mg/l• Acid Neutralizing Capacity ≥ 50 $\mu\text{eq/l}$• Dissolved Oxygen ≥ 4 ppm• Nitrate ≤ 300 $\mu\text{eq/l}$• Urban land use $\leq 20\%$ of catchment area• Forest land use $\geq 25\%$ of catchment area• Instream habitat rating optimal or suboptimal• Riparian buffer width $\geq 15\text{m}$• No channelization• No point source discharges

Table 2

Habitat Assessment

A general **habitat assessment** is crucial in evaluating the **ecological integrity** of a site. The assessment is done using a visually-based approach to characterizing the physical habitat structure of the stream site (Figure 7).

Habitat assessment evaluates the human-induced degradation (Figure 8) of the habitat.

Parameters are selected to measure various aspects of the habitat structure and to allow for an integrated assessment of the site.

Appropriate parameters are selected for the type of stream under study, and may differ widely between **high gradient** or **low gradient** (Figures 9 and 10) streams.

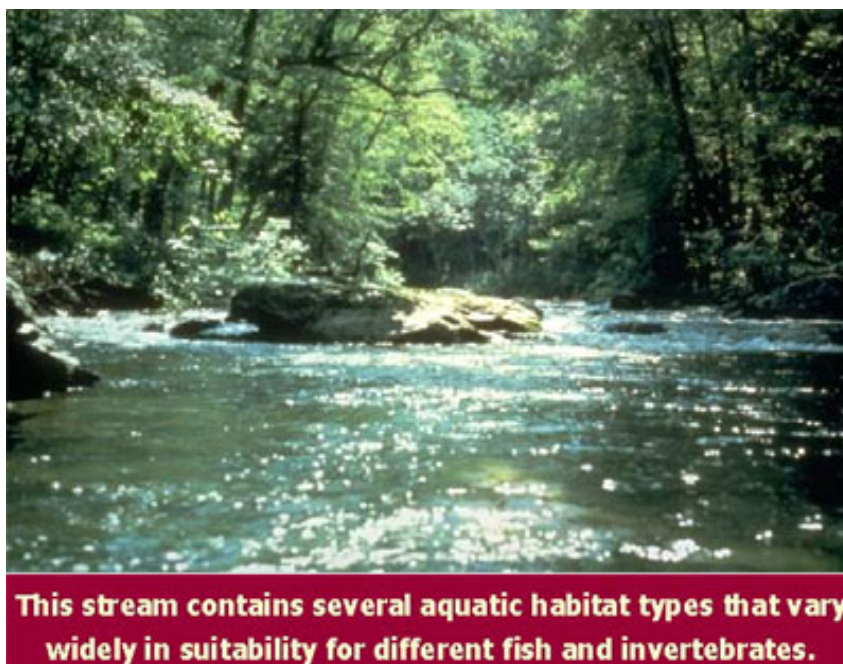

Figure 7

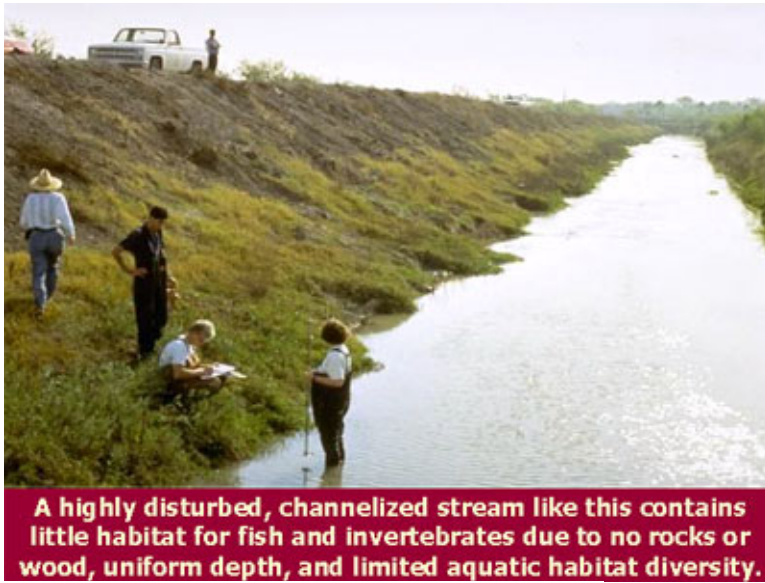

Figure 8

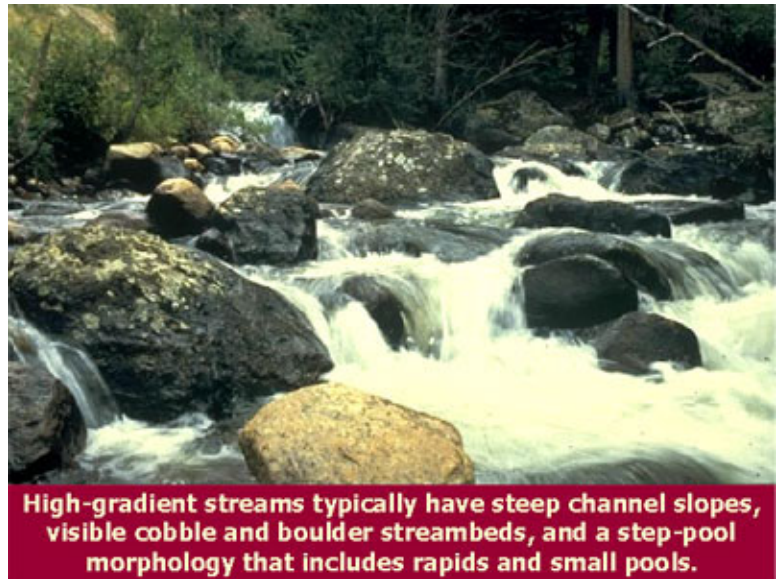
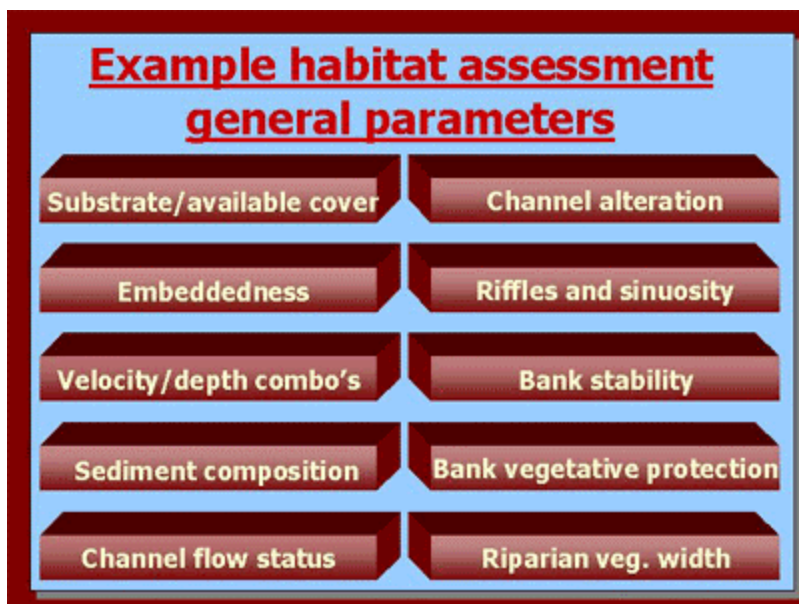

Figure 9



Figure 10

Each parameter is assessed and rated on a scale from 0-20. All of the ratings are totaled to derive a habitat ranking for the site. The habitat ranking is compared against the reference condition to make an assessment relative to the region. A successful visually-based assessment of the physical habitat structure depends on several factors:



- Relevant, clearly defined parameters (Figure 11)
- A continuum of conditions, from suboptimal to optimal, for each parameter;
- Measurable characteristics or categorical choices to minimize subjectivity in judging the attributes of each parameter;
- Experienced, adequately trained investigators; and
- Sufficient documentation and ongoing training to evaluate and correct errors.

Figure 11

Optimal habitat structure depends on several factors. **Structural heterogeneity** provides for diverse "**niche space**" and greater **species diversity**. An established, healthy habitat is important for **colonization stability**. Finally, a well-developed **energy base** is needed to support life and all related biological processes. The quality of the physical habitat restricts the biological potential of a site. Habitat and **biological diversity** are closely linked, and a degraded habitat structure is one of the primary stressors to aquatic life.

Water quality measurements (Figure 12) from the survey site are also pertinent to the assessment of the stream habitat. The RPBs call for direct measurements of temperature, **conductivity**, **dissolved oxygen**, **pH**, and **turbidity**. Notations on water odors and water surface oils are also taken. Water quality measurements taken at the time of the survey are used in combination with the physical characterization of the habitat to provide a more



Figure 12

insightful analysis of the site. Taken together, these data are good indicators of adverse impacts on the stream ecosystem and of the ability of the stream to support a healthy aquatic community. Click below for the RBP document's more detailed account of this topic, or continue with the remainder of this module and visit the full document site later.

Check this web site for further information on habitat and water quality measurements:
www.epa.gov/owow/monitoring/rbp/ch05main.html.

Biological Assemblages and Protocols

In addition to habitat and water quality information, integrated river and stream surveys also require data regarding the health of aquatic communities. These data are obtained through sampling one or more **biological assemblages**. Studying a group of organisms will, by their presence and relative abundance, provide useful information on the condition of their environment. The three assemblages used in the RPBs are **periphyton**, **benthic macroinvertebrates**, and fish (Figure 13).

When selecting an assemblage for river and stream bioassessment, the objective is to choose one or more assemblages that:

- Are useful and logical for the water body under study,
- Can be sampled and interpreted in a cost-effective way,
- Are consistent with the current mix of expertise available, and
- Can be easily interpreted and their results conveyed to managers (using, for example, a **multimetric index** of the assemblage.)



Assessing aquatic biota focuses on three assemblages:
fish, periphyton and benthic macroinvertebrates.

Figure 13

Different assemblages will require varying amounts of time and effort for sampling (Figure 14). This will largely depend on the specific characteristics of the watershed and the expertise and resources available to the agencies involved.

PERIPHYTON (Figure 15)

The periphyton assemblage is made up of **primary producers** that play a fundamental role in the stream ecosystem. Periphyton attaches to stream substrate and is directly affected by physical



Figure 14



Figure 15

and chemical changes that occur in the stream over time. Algae have a rapid reproduction rate and short life span, so they serve as an effective indicator of short-term environmental conditions and impacts. Sampling is relatively easy for this assemblage and causes little disturbance to resident biota. Some algae are vulnerable to low levels of pollutants, which do not affect other organisms until they are present at higher concentrations. This makes algae an effective "early warning" indicator, particularly for nutrient enrichment of the water body.

There are numerous methods available for periphyton sampling. Each should be considered in terms of the objectives of the program, the available resources, the number of streams that need to be sampled, the suspected stressors, and the physical habitat of the streams.

Technique 1

The field-based (i.e., processing done in field) rapid periphyton survey is useful for providing a quick, rough assessment of **benthic** algal biomass and **taxonomic composition** over a rather large scale. Besides a data sheet and a pencil, the only equipment needed is a meter stick and a "viewing bucket" with a clear acrylic bottom marked with a 50-dot grid. Before the assessment,

three transects are established in the site across areas with visible algal accumulation. Three locations are then selected along each of these transects. At each of these nine locations, the viewing bucket is submerged so that the algae is visible through the clear bottom of the bucket. Algal biomass is roughly characterized by counting the dots that occur over macroalgae and by measuring the length and thickness of algal accumulation. If several types of algae are present, each type is assessed separately. After the visual assessment is completed, some statistical characterization of the algae is useful. Mean density and the average percent cover by each type of algae is easily calculated, and these values make the assessment much more comprehensive.

Technique 2

The standard, laboratory-based (i.e., processing done in laboratory) approach for periphyton sampling is a bit more involved than the field-based survey, but it is not difficult. After the sampling area is established, a visual assessment is made to estimate the percent coverage for each substrate type and the relative abundance of the various types of periphyton present. After this is completed, it is time for sampling. Equipment needed may vary according to whether there will be sampling from natural substrates (Table 3) or artificial substrates (Table 4).

Algae samples are collected from all available substrates and habitats (e.g., **runs**, **riffles**, shallow pools, nearshore areas) to form one composite sample. This composite should be proportionally representative of the periphyton assemblage in the sampling area. The periphyton can be removed from the substrate by scraping or brushing. The composite sampled is stored in a jar with the appropriate preservative until it can be analyzed. It is important to store the periphyton composite in a cool dark place until that time. The exact method chosen will depend on the substrate type and other factors (Table 5).

Field Equipment for Periphyton Sampling— Natural Substrates

- stainless steel teaspoon, toothbrush, or similar brushing and scraping tools
- section of PVC pipe (3" diameter or larger) fitted with a rubber collar at one end
- field notebook or field forms*; pens and pencils
- white plastic or enamel pan
- petri dish and spatula (for collecting soft sediment)
- forceps, suction bulb, and disposable pipettes
- squeeze bottle with distilled water
- sample containers (125 ml wide-mouth jars)
- sample container labels
- preservative [Lugol's solution, 4% buffered formalin, "M3" fixative, or 2% glutaraldehyde (APHA 1995)]
- first aid kit
- cooler with ice

* During wet weather conditions, waterproof paper is useful or copies of field forms can be stored in a metal storage box (attached to a clip-board).

Table 3

**Field Equipment/Supplies Needed for Periphyton Sampling--
Artificial Substrates**

- periphytometer (frame to hold artificial substrata)
- microslides or other suitable substratum (e.g., clay tiles, sanded Plexiglass plates, or wooden or acrylic dowels)
- sledge hammer and rebar
- toothbrush, razor blade, or other scraping tools
- water bottle with distilled water
- white plastic or enamel pan
- aluminium foil
- sample containers
- sample container labels
- field notebook (waterproof)
- preservative [Lugol's solution, 4% buffered formalin, "M3" fixative, or 2% glutaraldehyde (APHA 1995)]
- cooler with ice

Table 4

Periphyton protocols are most useful when carried out with one or more of the other protocols, particularly with habitat and benthic macroinvertebrate assessments, because of the close association among these three elements. Two periphyton protocols are presented in the RBP document. Visit this Web site: www.epa.gov/owow/monitoring/rbp/ch06main.html to review these complete protocols.

**Summary of collection techniques for periphyton from wadeable streams
(adapted from Kentucky DEP 1993, Bahls 1993).**

Substrate Type	Collection Technique
Removable substrates (hard): gravel, pebbles, cobble, and woody debris	Remove representative substrates from water; brush or scrape representative area of algae from surface and rinse into sample jar.
Removable substrates (soft): mosses, macroalgae, vascular plants, root masses	Place a portion of the plant in a sample container with some water. Shake it vigorously and rub it gently to remove algae. Remove plant from sample container.
Large substrates (not removable): boulders, bedrock, logs, trees, roots	Place PVC pipe with a neoprene collar at one end on the substrate so that the collar is sealed against the substrate. Dislodge algae in the pipe with a toothbrush, nail brush, or scraper. Remove algae from pipe with pipette.
Loose sediments: sand, silt, fine particulate organic matter, clay	Invert petri dish over sediments. Trap sediments in petri dish by inserting spatula under dish. Remove sediments from stream and rinse into sampling container. Algal samples from depositional habitats can also be collected with spoons, forceps, or pipette.

Table 5

Benthic Macroinvertebrates

Benthic macroinvertebrates are the most widely used biological assemblage for monitoring in state water resource agencies (Figure 16). They are susceptible to degradation of water, sediment, and habitat, and therefore serve as good indicators of localized environmental conditions (Figure 17).

There are many advantages to using this assemblage. They are affected by various short-term environmental stressors throughout their different life stages. Certain stages will be more



Figure 16



Figure 17

Technique 1

The single habitat approach (Table 6) to field sampling is the method that was emphasized in the original RBPs. Benthic macroinvertebrate diversity and abundance are usually greatest in cobble substrate or riffle/run habitats, so sampling usually focuses on these habitat types. An alternate habitat is sampled when the cobble substrate type represents less than 30% of the sampling area based on the reference streams for the area. Before sampling,

sensitive than others to particular stressors. Benthic macroinvertebrates in a sensitive life stage will respond quickly to stress, while the entire assemblage will respond more slowly. Benthic macroinvertebrates also serve as a primary food source for many fish, and healthy fish communities are of great concern to most state water resource agencies. Finally, benthic sampling is relatively easy (Figure 18) and members of the assemblage are generally abundant in most waterbodies.



Figure 18

Field Equipment/Supplies Needed for Benthic Macroinvertebrate Sampling Single Habitat Approach

- standard kick-net, 500 opening mesh, 1.0 meter width
- sieve bucket, with 500 opening mesh
- 95% ethanol
- sample containers, sample container labels
- forceps
- pencils, clipboard
- Benthic Macroinvertebrate Field Data Sheet*
- first aid kit
- waders (chest-high or hip boots)
- rubber gloves (arm-length)
- camera
- Global Positioning System (GPS) Unit

* It is helpful to copy fieldsheets onto water-resistant paper for use in wet weather conditions

Table 6

a 100-meter reach (or some multiple of the stream reach) of the stream should be selected that is representative of the overall characteristics of the stream. The sampling crew should draw a map of the sampling reach and document local land use, site description, and weather conditions.

A **composite** sample is taken from individual spots in the riffles and runs that represent different velocities. Sampling starts at the downstream end of the reach and proceeds upstream. There are various types of sampling nets (Table 7) that can be used, but sampling is usually done with a 1 m kick net. The "kicks" collected from different locations in the stream reach will be composited for a single sample. The percentage of each habitat type in the reach is recorded on the field sheet. The sampling conditions and gear types used should be noted, along with a qualitative estimate of macroinvertebrate composition and abundance. After the sampling is completed, the samples are preserved and returned to the laboratory.

Technique 2

The multihabitat approach (Table 8) is preferred for streams dominated by sandy or silty sediments or with variable habitat structure. This method ensures that major habitat types (Table 9) are sampled in proportion to their occurrence in the sampling reach. A 100-meter reach of the stream should be selected that is representative of the overall characteristics of the stream. The samplers should then draw a map of the sampling reach and document local land use, a site description, and weather conditions. Sampling will begin at the downstream end of the reach and proceed upstream. The benthic macroinvertebrate samples are collected from each instream habitat by kicking the substrate or by jabbing it with a D-frame dip net. A total of 20 jabs (with the D-frame dip net) or kicks (with the kick net) will be taken from the entire sampling reach. Each habitat type should be sampled in proportion to its occurrence in the reach. The organisms collected are then composited into a single sample. The samples should be preserved in 95% ethanol and labeled.

Standard Benthic Macroinvertebrate Sampling Gear Types for Streams (assumes standard mesh size of 500 æ nytex screen)
<p>Kick net: Dimensions of net are 1 meter (m) x 1 m attached to 2 poles and functions similarly to a fish kick seine. Is most efficient for sampling cobble substrate (i.e., riffles and runs) where velocity of water will transport dislodged organisms into net. Designed to sample 1 m² of substrate at a time and can be used in any depth from a few centimeters to just below 1m (Note -- Depths of 1m or greater will be difficult to sample with any gear).</p>
<p>D-frame dip net: Dimensions of frame are 0.3 m width and 0.3 m height and shaped as a "D" where frame attaches to long pole. Net is cone or bag-shaped for capture of organisms. Can be used in a variety of habitat types and used as a kick net, or for "jabbing", "dipping", or "sweeping".</p>
<p>Rectangular dip net: Dimensions of frame are 0.5 m width and 0.3 m height and attached to a long pole. Net is cone or bag-shaped. Sampling is conducted similarly to the D-frame.</p>
<p>Surber: Dimensions of frame are 0.3 m x 0.3 m, which is horizontally placed on cobble substrate to delineate a 0.09 m² area. A vertical section of the frame has the net attached and captures the dislodged organisms from the sampling area. Is restricted to depths of less than 0.3 m.</p>
<p>Hess: Dimensions of frame are a metal cylinder approximately 0.5 m in diameter and samples an area 0.8 m². Is an advanced design of the Surber and is intended to prevent escape of organisms and contamination from drift. Is restricted to depths of less than 0.5 m.</p>

Table 7

Field Equipment/Supplies Needed for Benthic Macroinvertebrate Sampling: Multi-habitat Approach
<ul style="list-style-type: none"> • standard D-frame dip net, 500 opening mesh, 0.3 m width (~ 1.0 ft frame width) • sieve bucket, with 500 opening mesh • 95% ethanol • sample containers, sample container labels • forceps • pencils, clipboard • Benthic Macroinvertebrate Field Data Sheet* • first aid kit • waders (chest-high or hip boots) • rubber gloves (arm-length) • camera • Global Positioning System (GPS) Unit <p>* It is helpful to copy fieldsheets onto water-resistant paper for use in wet weather conditions</p>

Table 8

Habitat Types

The major stream habitat types listed here are in reference to those that are colonized by macroinvertebrates and generally support the diversity of the macroinvertebrate assemblage in stream ecosystems. Some combination of these habitats would be sampled in the multihabitat approach to benthic sampling.

Cobble (hard substrate) - Cobble will be prevalent in the riffles (and runs), which are a common feature throughout most mountain and piedmont streams. In many high- gradient streams, this habitat type will be dominant. However, riffles are not a common feature of most coastal or other low-gradient streams. Sample shallow areas with coarse (mixed gravel, cobble or larger) substrates by holding the bottom of the dip net against the substrate and dislodging organisms by kicking the substrate for 0.5 m upstream of the net.

Snags - Snags and other woody debris that have been submerged for a relatively long period (not recent deadfall) provide excellent colonization habitat. Sample submerged woody debris by jabbing in medium-sized snag material (sticks and branches). The snag habitat may be kicked first to help dislodge organisms, but only after placing the net downstream of the snag. Accumulated woody material in pool areas are considered snag habitat. Large logs should be avoided because they are generally difficult to sample adequately.

Vegetated banks - When lower banks are submerged and have roots and emergent plants associated with them, they are sampled in a fashion similar to snags. Submerged areas of undercut banks are good habitats to sample. Sample banks with protruding roots and plants by jabbing into the habitat. Bank habitat can be kicked first to help dislodge organisms, but only after placing the net downstream.

Submerged macrophytes - Submerged macrophytes are seasonal in their occurrence and may not be a common feature of many streams, particularly those that are high-gradient. Sample aquatic plants that are rooted on the bottom of the stream in deep water by drawing the net through the vegetation from the bottom to the surface of the water (maximum of 0.5 m each jab). In shallow water, sample by bumping or jabbing the net along the bottom in the rooted area, avoiding sediments where possible.

Sand (and other fine sediment) - Usually the least productive macroinvertebrate habitat in streams, this habitat may be the most prevalent in some streams. Sample banks of unvegetated or soft soil by bumping the net along the surface of the substrate rather than dragging the net through soft substrates; this reduces the amount of debris in the sample.

Table 9

Technique 3

The biological reconnaissance (BioRecon) is a biological survey technique that can be used to screen potential sampling sites and then differentiate between impaired and non-impaired sites (Table 10). When performed by an experienced, locally knowledgeable biologist, a large number of sites can be rapidly screened, and the areas needing further study can be targeted. This approach is used to cut down time spent in the laboratory and with analysis. Either field or laboratory identification can be done with this technique.

Field Equipment/supplies Needed for Benthic Macroinvertebrate Sampling: Bioreconnaissance
<ul style="list-style-type: none">• standard D-frame dip net, 500 opening mesh, 0.3 meter width (~ 1.0 ft frame width)• sieve bucket, with 500 opening mesh• 95% ethanol• sample containers• sample container labels• forceps• field data sheets*, pencils, clipboard• first aid kit• waders (chest-high or hip boots), rubber gloves (arm-length)• camera• Global Positioning System (GPS) Unit <p>* It is helpful to copy fieldsheets onto water-resistant paper for use in wet weather conditions</p>

Table 10

A 100-meter reach that is representative of the stream is selected for the BioRecon. Site description, weather conditions, and land use are recorded on the field data form. Sampling begins at the downstream limit of the reach and proceeds upstream. Each major habitat type in the reach should be sampled for a total of four jabs or kicks over the entire reach. The collected organisms are composited into a sieve bucket to produce a single homogeneous sample. Sorting is done at the site, and organisms are identified and recorded on a tally sheet. A representative of each taxon is preserved and verified in the laboratory. Analysis is done by comparing the value of each **metric** to a predetermined value for the stream class. Sites with metric values below the threshold value are considered "suspect" of being impaired, and these sites may require further investigation and sampling.

Laboratory

Benthic macroinvertebrate samples should be processed in a laboratory (Figure 19) under controlled conditions.

Subsampling of benthic samples is sometimes used (although some scientists discourage it) to reduce the effort needed for sorting and identifying the macroinvertebrates, as keying out specimens can sometimes require long hours. To obtain a subsample, the entire composite sample should first be rinsed and then spread evenly across a pan marked with a grid. Using a random numbers table, four squares on the grid are selected,

and the organisms within this grid are used as the subsample. If still too many organisms are collected, the subsample can be spread out again and the process can be repeated. The final subsample should be placed in glass vials and preserved with 70% ethanol. (Figure 20)

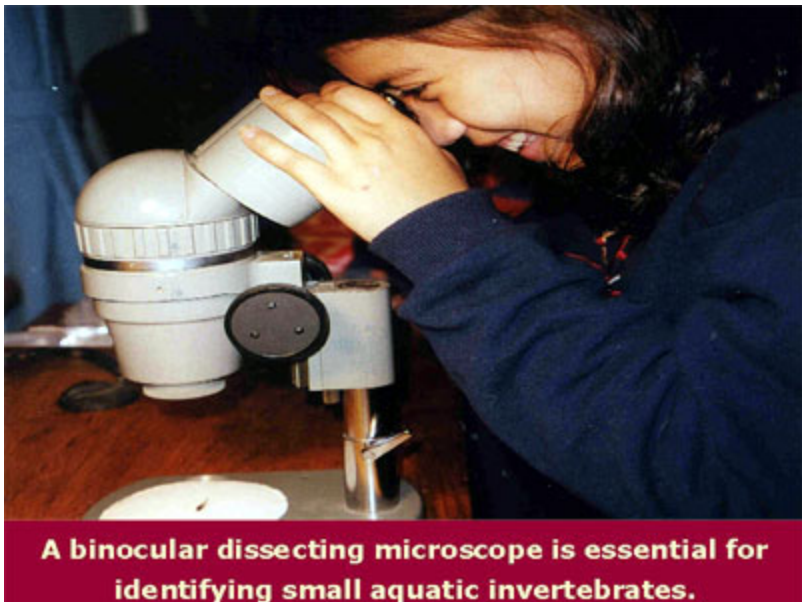

Figure 19



Figure 20

effective are those that have differences in response across a range of human influences. Recommended metrics are listed here (Table 11)

All three approaches to sampling the benthic macroinvertebrate assemblage are discussed in the protocol. Click on the Web site: www.epa.gov/owow/monitoring/rbp/ch07main.html to review the complete protocols.

Taxonomic identification of the organisms can be done to any level, but it must be done consistently among samples. Identification to **genus** or **species** level provides more specific information about sensitivity to impairment and on ecological/environmental relationships. Identification to the **family** level requires less expertise to perform and will usually speed up the assessment process.

Metrics for benthic macroinvertebrates have been used in several different indices. The metrics that are most

Definitions of best candidate benthic metrics and predicted direction of metric response to increasing perturbation

(compiled from DeShon 1995, Barbour et al. 1996b, Fore et al. 1996, Smith and Voshell 1997).

Category	Metric	Definition	Predicted response to increasing perturbation
Richness measures	Total No. taxa	Measures the overall variety of the macroinvertebrate assemblage	Decrease
	No. EPT taxa	Number of taxa in the insect orders Ephemeroptera (mayflies), Plecoptera (stoneflies), and Trichoptera (caddisflies)	Decrease
	No. Ephemeroptera Taxa	Number of mayfly taxa (usually genus or species level)	Decrease
	No. Plecoptera Taxa	Number of stonefly taxa (usually genus or species level)	Decrease
	No. Trichoptera Taxa	Number of caddisfly taxa (usually genus or species level)	Decrease
Composition measures	% EPT	Percent of the composite of mayfly, stonefly, and caddisfly larvae	Decrease
	% Ephemeroptera	Percent of mayfly nymphs	Decrease
Tolerance/Intolerance measures	No. of Intolerant Taxa	Taxa richness of those organisms considered to be sensitive to perturbation	Decrease
	% Tolerant Organisms	Percent of macrobenthos considered to be tolerant of various types of perturbation	Increase
	% Dominant Taxon	Measures the dominance of the single most abundant taxon. Can be calculated as dominant 2, 3, 4, or 5 taxa.	Increase
Feeding measures	% Filterers	Percent of the macrobenthos that filter FPOM from either the water column or sediment	Variable
	% Grazers and Scrapers	Percent of the macrobenthos that scrape or graze upon periphyton	Decrease
Habit measures	Number of Clinger Taxa	Number of taxa of insects	Decrease
	% Clingers	Percent of insects having fixed retreats or adaptations for attachment to surfaces in flowing water.	Decrease

Table 11

Fish

The fish assemblage is a crucial component of many water quality monitoring programs. State agencies strive to maintain and manage "fishable" waters and guard fish reproduction. Bioassessments of the fish assemblage convey information about the overall health of the stream ecosystem as well as about fish populations (Figure 21). Fish are relatively long-lived and mobile, so they serve as good indicators of long-term environmental effects and broad habitat conditions. They are at or close to the top of the aquatic food web and some are consumed by humans, so there is a public interest in assessing contamination at this level. Fish are relatively easy to sample and identify in the field, and the environmental requirements of most fish species are well known and commonly available.

Fish sampling uses a multihabitat approach. Various habitats are sampled in proportion to their representation within the sampling reach. Each reach should contain riffle, run, and pool habitat samples, if possible. Prior to sample collection, a habitat assessment should be performed. Physical and chemical parameters should be measured at the same time as fish sampling to specifically characterize the habitat.

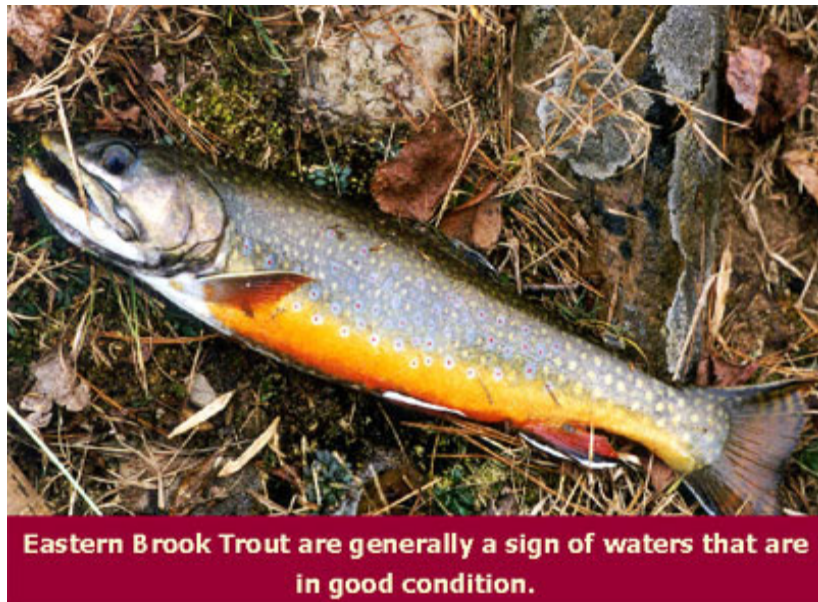

Figure 21



Figure 22

collection should begin at a shallow riffle at the downstream limit of the sampling reach, and it should end at a similar riffle at the upstream limit of the reach. All of the wadeable habitats within the reach should be sampled. Fish should be held in livewells (or buckets) until they can be identified and counted (Figure 23). Fish must then be identified to species or subspecies. If this cannot be done in the field, then the unknown specimen should be preserved in a 10% formalin solution and labeled for laboratory identification (but this is not recommended in rare fish habitats). The percentage of each habitat type should be estimated in the reach and included on the field data sheet. For more details about electrofishing methodology and options, see Table 12.

The single most efficient method for collecting a representative sample of stream fishes is through **electrofishing** (Figure 22). There are several different types of electrofishing equipment available; the type used will depend on the habitat conditions, personnel experience, and agency resources. Because of the hazardous nature of this method, the fish collection team must be adequately trained and experienced.

Block nets should be set up at the ends of the reach before sampling begins. Electrofishing



This Sculpin captured in a stream is temporarily being held in an aquarium until its species is positively identified.

As with the other assemblages, a multimetric approach is used that incorporates the zoogeographic, ecosystem, community, and population aspects of fisheries biology into a single ecologically based index of the quality of the water resource. The RBPs multimetric index integrates different types of information about the fish assemblage into an ecologically based index that is used to make planning and management decisions. It is an aggregation of twelve

Figure 23

<i>Electrofishing Configuration and Field Team Organization</i>
<p>All field team members must be trained in electrofishing safety precautions and unit operation procedures identified by the electrofishing unit manufacturer. Each team member must be insulated from the water and the electrodes; therefore, chest waders and rubber gloves are required. Electrode and dip net handles must be constructed of insulating materials (e.g., woods, fiberglass). Electrofishers/electrodes must be equipped with functional safety switches (as installed by virtually all electrofisher manufacturers). Field team members must not reach into the water unless the electrodes have been removed from the water or the electrofisher has been disengaged.</p> <p>It is recommended that at least 2 fish collection team members be certified in CPR (cardiopulmonary resuscitation). Many options exist for electrofisher configuration and field team organization; however, procedures will always involve pulsed DC electrofishing and a minimum 2-person team for sampling streams and wadeable rivers. Examples include:</p>
<ul style="list-style-type: none"> • Backpack electrofisher with 2 hand-held electrodes mounted on fiberglass poles, one positive (anode) and one negative (cathode). One crew member, identified as the electrofisher unit operator, carries the backpack unit and manipulates both the anode and cathode poles. The anode may be fitted with a net ring (and shallow net) to allow the unit operator to net specimens. The remaining 1 or 2 team members net fish with dip nets and are responsible for specimen transport and care in buckets or livewells.
<ul style="list-style-type: none"> • Backpack electrofisher with 1 hand-held anode pole and a trailing or floating cathode. The electrofisher unit operator manipulates the anode with one hand, and has a second hand free for use of a dip net. The remaining 1 or 2 team members also aid in the netting of specimens, and in addition are responsible for specimen transport in buckets or livewells.
<ul style="list-style-type: none"> • Tote barge (pram unit) electrofisher with 2 hand-held anode poles and a trailing/floating cathode (recommended for large streams and wadeable rivers). Two team members are each equipped with an anode pole and a dip net. Each is responsible for electrofishing and the netting of specimens. The remaining team member will follow, pushing or pulling the barge through the sample reach. A livewell is maintained within the barge and/or within the sampling reach but outside the area of electric current.

Table 12

biological metrics that are based on species and trophic composition of the fish assemblage as well as the abundance and condition of fish. These metrics work to quantify the professional judgements of biologists into a measure that will indicate the quality of the fish assemblage.

To review the entire fish protocol, visit this Web site: www.epa.gov/owow/monitoring/rbp/ch08main.html.

Data Analysis

Biosurveys do not end after the biological data are collected in the field or laboratory. The data must then be translated into a usable form for making water resource management decisions (Figure 24).



Figure 24

There are basically two data analysis strategies commonly used by water resource agencies. In the United States, the **multimetric approach** is primarily used, while many agencies in Europe and Australia advocate the **multivariate approach**. In this module, as in the RPBs, the focus is on the multimetric approach.

To review, a **metric** was defined earlier as a measurable characteristic of the biota that changes in some predictable way with increased human influence. A metric is chosen based on its responsiveness to stressors and its capacity to discriminate between optimal and degraded sites.

The metric must have low natural variability so that a change will have significance, and that significance should be relatively easy to interpret. Finally, the metric should be cost-effective to measure. A variety of widely-used metrics are available for consideration (Table 13).

The multimetric approach uses simple **univariate** statistics to analyze biological data. This approach is broadly applicable to many different types of streams in different regions. The procedures that are used are sensitive to many stressors, making this approach relatively comprehensive. It also yields consistent, reproducible results, which is evidence of its strength as a analytical tool.

The multimetric approach is based on the premise that undegraded biological systems have distinctive structural and functional attributes. The metrics used in this approach are composites of information that are representative of collective community attributes. It is important to understand the effects of certain stressors on the behavior of specific metrics. The departure of a metric from a pristine condition is correlated with a degree of degradation. The synthesis of numerous metrics provides a gauge that can be used to measure the overall integrity of the system.

Metrics that have a well-characterized response to specific pollutants or stressors are the most useful as a diagnostic tool. Core metrics are the ones that are sensitive to pollution and describe the ecological relationships of the assemblage to specific stressors or cumulative impacts. Both

reference data and test site data are used to evaluate the candidate metrics and to calibrate the set of candidates into a group of useful core metrics. They represent diverse aspects of structure, composition, individual health, and processes of the aquatic biota. Collectively, they are used to make a solid, integrated analysis of biotic condition to judge the fulfillment of **biological criteria**.

Some potential metrics for periphyton, benthic macroinvertebrates, and fish that could be considered for streams. Redundancy can be evaluated during the calibration phase to eliminate overlapping metrics.

When unlike measurements are combined, the values must be standardized so that the measurements are made unitless. The typical means for comparing and interpreting unlike metric values is through standardizing the measurements into a logical progression of scores (for example, a rating of 1 to 5). This process is the first part of **index** development. A relative score of "1", "3", or "5" is assigned to a site according to how it "measures up" to the reference site. A score of "5" indicates that the conditions of the assessed site are relatively close to that of the reference site. A score of "1" suggests that the conditions of the assessed site are degraded compared to the reference site, and a score of "3" indicates conditions somewhere in the middle.

	Richness Measures	Composition Measures	Tolerance Measures	Trophic/Habit Measures
Periphyton	<ul style="list-style-type: none"> • Total # of taxa • # of common nondiatom taxa • # of diatom taxa 	<ul style="list-style-type: none"> • % community similarity • % live diatoms • Diatoms (Shannon) 	<ul style="list-style-type: none"> • % tolerant diatoms • % sensitive taxa • % aberrant diatoms 	<ul style="list-style-type: none"> • % motile taxa • Chlorophyll <i>a</i> • % saprobiontic • % eutrophic
Benthic	<ul style="list-style-type: none"> • # of total taxa • # of EPT taxa • # of Ephemeroptera taxa • # of Plecoptera taxa 	<ul style="list-style-type: none"> • % EPT • % Ephemeroptera • % Chironomidae 	<ul style="list-style-type: none"> • # of intolerant Taxa • % Tolerant Organisms • Hilsenhoff Biotic Index (HBI) • % Dominant 	<ul style="list-style-type: none"> • # of clinger taxa • % Clingers • % Filterers • % Scrapers
Fish	<ul style="list-style-type: none"> • Total # of native fish species • # and identity of darter species • # and identity of sunfish species • # and identity of sucker species 	<ul style="list-style-type: none"> • % pioneering species • # of fish per unit of sampling effort related to drainage area 	<ul style="list-style-type: none"> • # and identity of intolerant species • % of individuals as tolerant species • % of individuals as hybrids • % of individuals with disease, tumors, fin damage, and skeletal anomalies 	<ul style="list-style-type: none"> • % omnivores • % insectivores • % top carnivores

Table 13

The choice of cut-off points that determine which score a site will receive depends on the confidence the researcher has in the reference site.

(Note: Biological monitoring should combine solid biological data with valid statistical design methods, but the subject of statistics and monitoring design is beyond the scope of this module. Refer to the Watershed Academy Web module on monitoring (www.epa.gov/watertrain/monitoring/) for more guidance on basics of monitoring program design.

Translating Biological Data

The multimetric index serves as a practical method for summarizing the diverse types of biological data that are collected during an assessment. It also provides an effective means to communicate these data.

The biological condition of waters is of interest to many different people of varying backgrounds. Because of this, the data report must be coherent and clearly presented. The goal is to make the report easy to understand for everyone who may read it, from community members to elected officials to managers (Figure 25). Many of these people do not have a background in biology, but they will be the ones utilizing the information in the report to make decisions.

State water resource agencies are encouraged to use more than one biological assemblage when conducting a bioassessment. This provides a much more comprehensive diagnosis of the water resource. However, this approach also presents the issue of integrating the data from multiple assemblages into one understandable report. Sometimes, the findings for each assemblage even suggest a contradiction in the assessment. These contradictions need not be seen as a complication. The various assemblages respond to stressors differently; these differences in

results can often be used to analyze the possible causes of impairment.



Recording data carefully onsite is just the beginning of assessment, which must later translate data into information useful for supporting decision-making.

Another part of the data that must be integrated into the assessment report is the habitat quality information. Oftentimes, aquatic organisms have very specific habitat requirements that are independent of water quality. If habitat quality issues are not addressed, then an incomplete message about the overall site condition will be conveyed. The relationship between habitat quality and biological condition can be graphed to effectively show how they are interrelated.

Figure 25

Graphic Display of RBP Data

Different types of graphs can be used to effectively explain different types of scientific information.

Before choosing a graphing technique, one must first consider exactly what it is that is important to communicate. Do you want to show the distinction between and among site classes or groups? Do you want to consolidate the information from many samples to show the status of stream conditions? Do you want to show trends that may indicate improvement, degradation, or no change? Certain types of graphs lend themselves particularly well to depicting specific types of information or relationships, and thus the choice of graphic style should be carefully thought out.



Figure 26

Some of the more useful graphical techniques are listed in Figure 26. Figures 27-33 on the following pages contain more information on each technique.

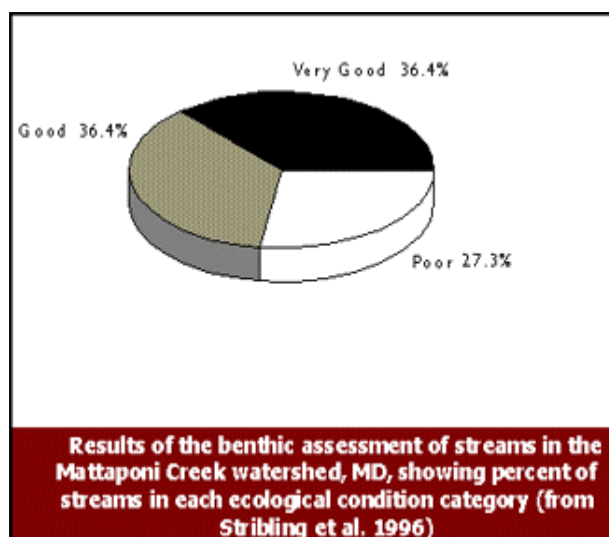

Figure 27. Pie charts are used to illustrate the proportional representation of the whole by its component parts

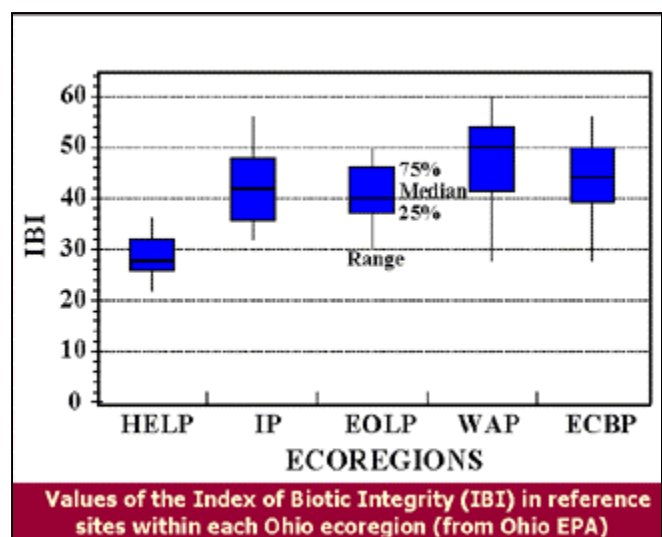

Figure 28. Box and whisker plots are used to explain population attributes through percentile distributions. They convey to the reader some sense of the variability within each data set.

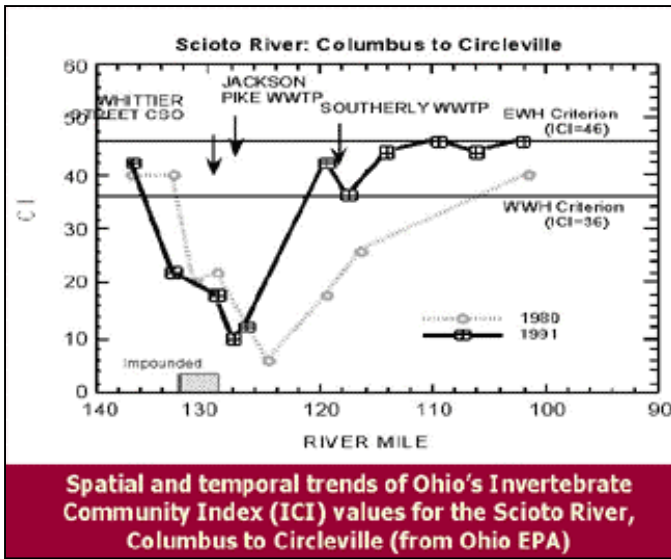

Figure 28. Line graphs illustrate contiguous spatial or temporal trends. The connection between two points on the graph is linear.

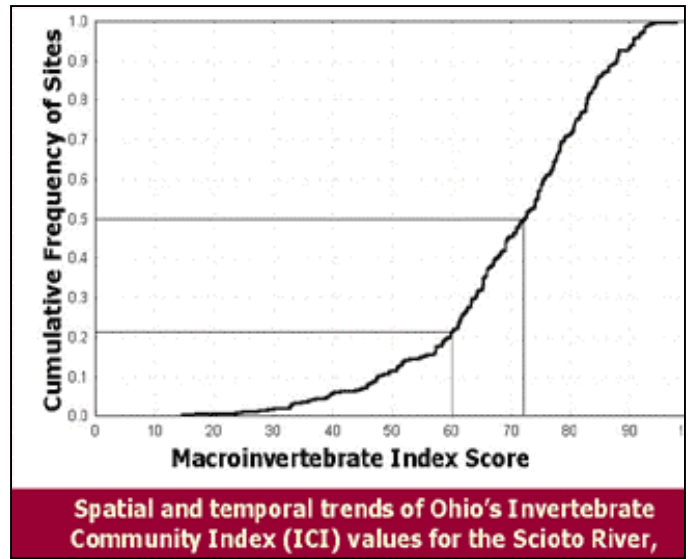

Figure 29. Cumulative frequency diagrams are used to show an ordered accumulation of observations from the lowest to highest value. This graphical technique allows the reader to determine the status of the resource at any certain level.

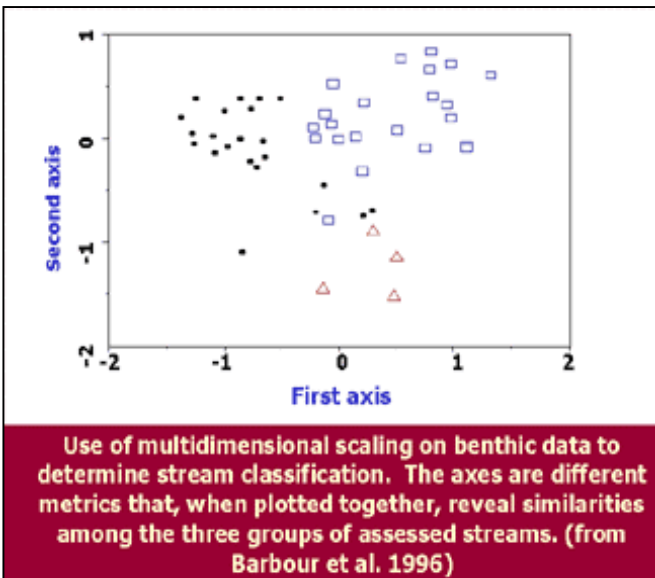

Figure 30 Bivariate scatter plots are used to compare the clustering of points using two dimensions. This technique can be used to develop regression lines or even to incorporate three factors of data.

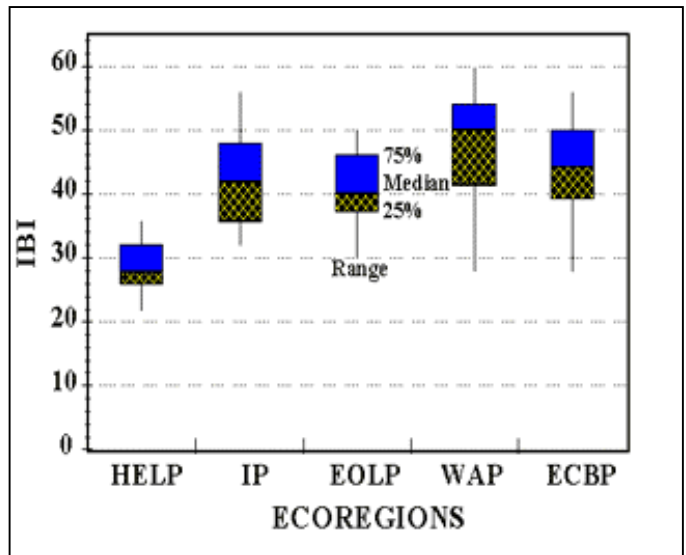

Figure 31. A cluster dendrogram is used to show clustering and the similarities and differences between sites.

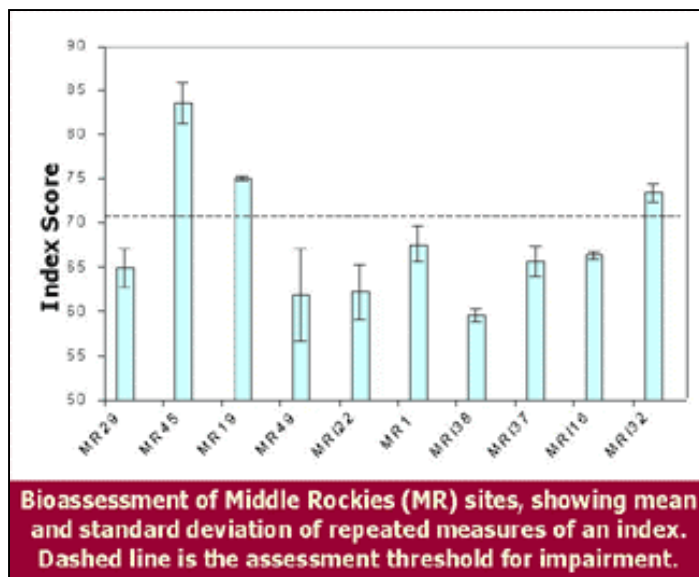

Figure 32. Bar charts are used to display magnitude values for individual measures. They can be used to illustrate deviation from a value of central tendency.

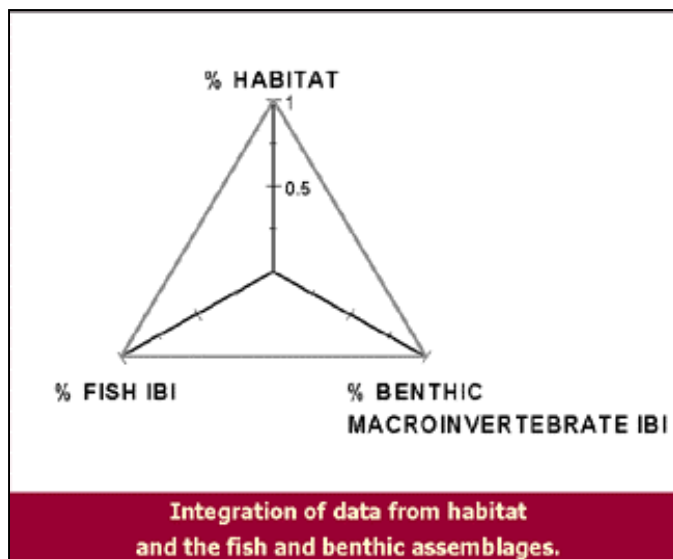

Figure 33. Sun ray plots are used to compare more than two endpoints or data types. They are most effective when the reference condition is incorporated into the axes.

Reporting of Biological Data



Figure 34

allowing non-technical audiences to understand it and make informed decisions. Graphics may be used to illustrate the results of the study. Appendices should accompany the report to provide technical support.

The format used to report an ecological assessment depends largely on the intended audience (Figure 34). No matter who is the audience, the format should outline the scientific process, focus on the study objectives, and judge the condition of assessed sites. Two basic report formats are recommended. The "summary report" format is used by resource managers for decision-making and policy-making regarding the water resource. This format is also useful for conveying information to the public. The more formal scientific report is structured after peer-reviewed journals and is designed for a more technical audience.

The *Ecosummary* presented in Figure 35 on the next page is an example of the summary report. It quickly and effectively conveys information about the study including the results. The format is uncomplicated,

The scientific report is much more inclusive and technical than the summary report. It is set up like a peer-reviewed journal. The study methods are presented completely and clearly. The report should first go through a peer review by non-agency scientists as a "quality control" check of its scientific credibility. An abstract should precede the report to summarize and stress the important findings of the study. Supporting literature should be included with the discussion of the results; this will give added strength to the findings.

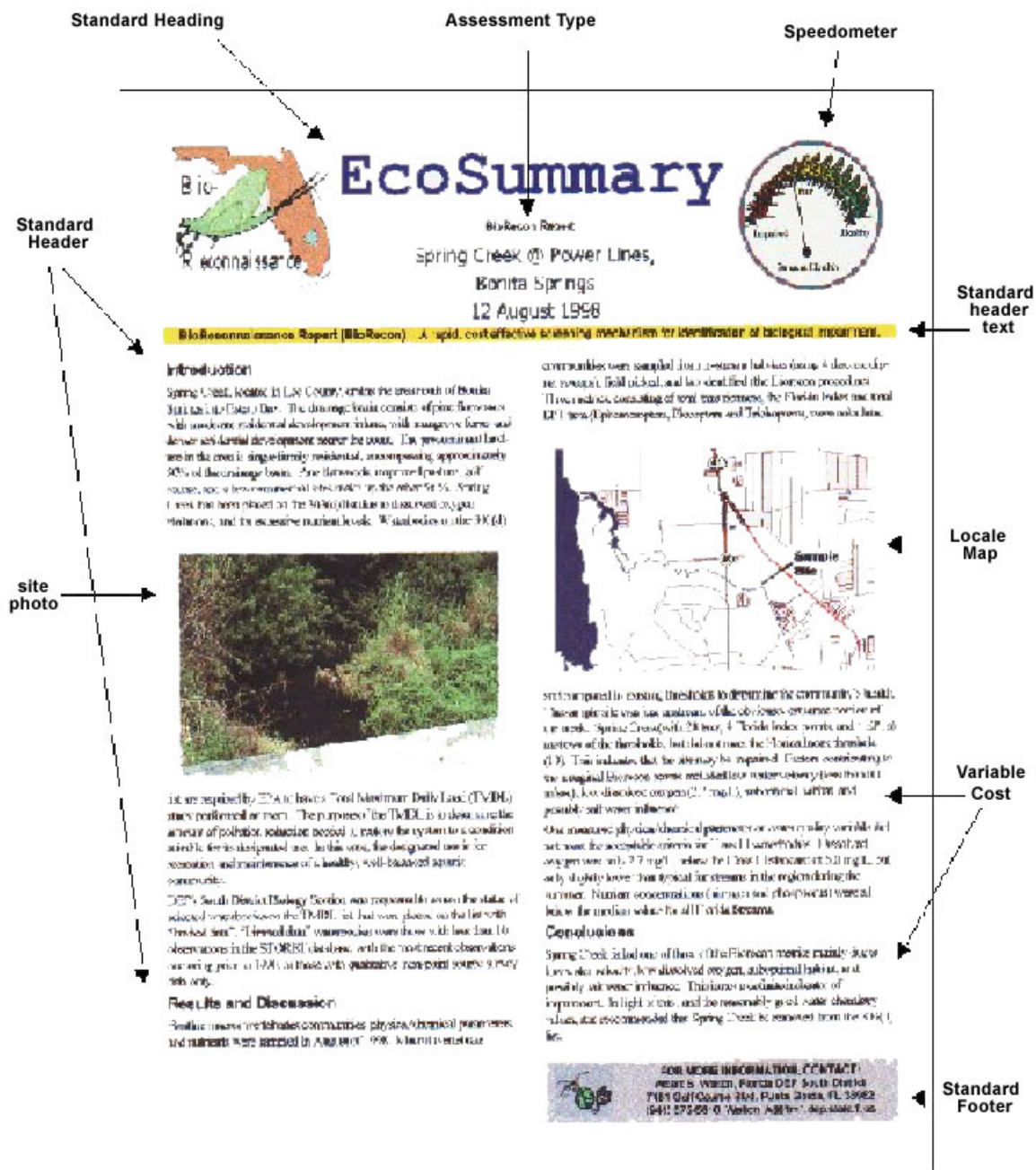

Figure 35

Acknowledgements

The late Dr. James L. Plafkin was the principal editor and co-author of the original RBPs document in 1989 and a driving force within EPA to increase the use of biological assessment in water pollution control programs until his untimely death in 1990. Chris Faulkner served as project officer for the revised, second edition protocols published in 1999. The authors also extend their appreciation to Jennifer Pitt and Abby Markowitz for their assistance in preparing this web-based training module.

Glossary for the Rapid Bioassessment Protocols Module

aquatic life use - a beneficial use designation (in state water quality standards) in which the waterbody provides suitable habitat for survival and reproduction of desirable fish, shellfish, and other aquatic organisms.

assemblage - an association of interacting populations of organisms in a given waterbody

benthic - of the bottom of a waterbody

benthic macroinvertebrates - animals without backbones, living in or on sediments or other substrates, of a size large enough to be seen by the unaided eye, and which can be retained by a U.S. Standard No. 30 sieve (28 openings per inch, 0.595-mm openings)

bioassessment - evaluation of the biological conditions of a waterbody that uses biological surveys of the resident plants, animals, and other living organisms that depend upon the aquatic resource.

biological assemblages - a group of phylogenetically or ecologically related organisms that are part of an aquatic community

biological criteria - under the Clean Water Act, numerical values or narrative statements that define a desired biological condition for a waterbody and are part of the water quality standards.

biological diversity - the variety and variability among living organisms and the ecosystems in which they occur. Biodiversity includes the numbers of different items and their relative frequencies; these items are organized at many levels, ranging from complete ecosystems to the biochemical structures that are the molecular basis of heredity. Thus, biodiversity encompasses expressions of the relative abundances of different ecosystems, species, and genes.

biomass - all of the living material in a given area

bioregions - homogeneous areas defined by similarity of climate, landforms, soil, potential natural vegetation, hydrology, or other relevant physical, chemical, or biological variables

colonization stability - Ability to reside in a semi-permanent status; not transient.

composite - aggregate of more than one sampling effort

conductivity - the measure of the ionic strength or concentration in water

dissolved oxygen - oxygen dissolved in water and available for living organisms to use for respiration

ecological integrity - the condition of the biotic (aquatic community) and abiotic (water chemistry and habitat) components of unimpaired waterbodies as measured by assemblage (an

association of interacting populations of organisms in a given waterbody, e.g., fish assemblage) structure and function, water chemistry, and habitat measures of a site.

electrofishing - a fish sampling technique using electric currents and electric fields to control fish movement and/or immobilize fish, allowing capture

empirical model - a simplified representation of a system or phenomenon that is based on experience or experimentation.

energy base - basis for organization of trophic levels, or feeding strategies, in the system. Energy can be derived from within (e.g., photosynthesis) or outside (e.g., leaf fall) of the aquatic system.

family - a taxonomic level of organization containing several genera and multiple species

genus - an associated group of species

habitat - a place where the physical and biological elements of ecosystems provide a suitable environment including the food, cover, and space resources needed for plant and animal livelihood.

habitat assessment - the evaluation of the structure of the surrounding habitat that influences the quality of the water resource and the condition of the aquatic community

high gradient streams - streams in moderately to highly sloping landscapes having substrate primarily composed of coarse sediment particles or frequent coarse particulate aggregations along stream reaches

index - a usually dimensionless, numeric combination of scores derived from biological measures called metrics

low gradient streams - streams in low to moderately sloping landscapes having substrates of fine sediment or infrequent aggregations of coarse particulate aggregations along stream reaches

metric - a measurable characteristic of the biota that changes in some predictable way with increased human influence.

multimetric approach - analysis techniques using several measurable characteristics of a biological assemblage

multimetric index - A dimensionless numeric combination of scores derived from biological measures called metrics. A metric is a characteristic of the biota that changes in some predictable way with increased human influence and can therefore be scored according to conditions.

multivariate approach - statistical methods (e.g., ordination or discriminant analysis) for analyzing physical and biological community data using multiple variables

niche space - the position of a particular species or population in an ecological community

parameter - a determining characteristic or factor

periphyton - a broad organismal assemblage composed of attached algae, bacteria, their secretions, associated detritus, and various species of microinvertebrates

pH - a numerical measure of the hydrogen ion concentration used to indicate the alkalinity or acidity of a substance

primary producers - organisms capable of producing their own food, e.g., algae

reference conditions - expectations on the state of aquatic biological communities in the absence of human disturbance and pollution.

reference sites - real sites that are used for characterizing reference conditions. These sites should be minimally impaired by human disturbance and pollution.

riffles - shallow areas in a stream where water flows swiftly over gravel and rock

runs - deep areas in a stream where water flows fast with little or no turbulence.

species - fundamental category of classification consisting of organisms capable of interbreeding

species diversity - the variance of distinct species that are found in an assemblage community, or sample.

structural heterogeneity - composed of parts of different kinds, or having widely dissimilar elements

taxonomic composition - the number and arrangement of distinct species that are found in an assemblage

turbidity - murkiness or cloudiness of water, indicating the presence of some suspended sediments, dissolved solids, natural or man-made chemicals, algae, etc.

univariate - statistical tests for comparing two or more groups; techniques include t-test, analysis of variance, sign test, Wilcoxon rank test, and the Mann-Whitney U-test

variance - a measure of the variability or precision of a set of observations.

Water Quality Standard - A law or regulation that consists of the beneficial designated use or uses of a water body, the numerical and narrative water-quality criteria that are necessary to protect the use or uses of that particular water body, and an antidegradation statement. Water quality standards are set by States, Territories, and Tribes. They identify the uses for each waterbody, for example, drinking water supply, contact recreation (swimming), and aquatic life support (fishing), and the scientific criteria to support that use. (From federal Clean Water Act)

zoogeographic - concerning geographic distribution of animal populations and assemblages